

SMART INTEGO

Product Catalogue



THE FINEST IN KEYLESS SECURITY

Valid from 1st February 2020

Simons & Voss
technologies



03 SMART INTEGO

04 THE PERFECT SOLUTION FOR INTEGRATED ACCESS CONTROL.

06 DIGITAL LOCKING CYLINDER – SMART INTEGO

- 08 Digital Euro Profile Double Thumb-Turn Cylinder SI – Comfort
 - 10 Digital Euro Profile Double Thumb-Turn Cylinder SI – FD
 - 12 Digital Euro Profile Double Thumb-Turn Cylinder SI – Anti-Panic
 - 14 Digital Euro Profile Half Cylinder – SI
 - 16 Digital Scandinavian Oval Cylinder – SI
 - 18 Digital Scandinavian Round Cylinder – SI
 - 20 Digital Swiss Round Double Thumb-Turn Cylinder – SI
 - 22 Digital Swiss Round Half Cylinder – SI
 - 24 Smart Intego - Accessories:
-

26 DIGITAL SMART HANDLE AX SMART INTEGO

- 29 Digital Smart Handle AX SI
 - 35 Digital Smart Handle AX SI for glass doors
-

36 DIGITAL SMART HANDLE SMART INTEGO

- 39 Digital SmartHandle – SI
 - 45 Cover for post-fitting (Euro/Swiss)
 - 46 Handle for post-fitting
 - 47 Digital SmartHandle – SKG – SI
 - 54 Digital SmartHandle – Scandinavian Oval – SI
-

56 DIGITAL PIN CODE TERMINAL SMART INTEGO

- 57 Digital Pin Code Terminal SI
-

58 DIGITAL PADLOCK SMART INTEGO

- 59 Digital Padlock SI
-

62 PROGRAMMING SMART INTEGO

- 63 Programming Device SmartIntego SmartCD
-

64 NETWORK STRUCTURE SMART INTEGO

- 66 GatewayNode – SI
-

68 CONFIGURATION SOFTWARE

- 69 Configuration Software SI
-

70 SUPPORT

- 71 Services and training
-

72 SIMONS VOSS AROUND THE GLOBE

NINE COMPELLING REASONS

Why SmartIntego has special appeal for operators of complex building systems.

- 1. Components proven the world over**
More than 12,000 installed digital locking and access control systems by SimonsVoss with over 1.2 million closures impress in their precision and reliability in tough practical use.
- 2. Supports all major card formats**
MIFARE® Classic, MIFARE® DESFire® / EV1/EV2, UID (card serial number) according to ISO 14443 (e.g. MIFARE®, Legic® Advant, HID® SEOS)
- 3. Made in Germany**
All system components are developed and produced to the highest standards exclusively in Germany.
- 4. Reduced integration work**
Efficient communication protocols and a high degree of automation thanks to the SmartIntego Manager reduces integration costs significantly.
- 5. Always ideally networked – virtually too**
The exchange of security-critical information between the access system and SmartIntego locking media is guaranteed for each locking operation in Virtual CardNetwork mode.
- 6. Unique radio technology**
Wider ranges in the wireless network due to 868-MHz technology ensures no interference from other networks, such as WLAN and Bluetooth etc. in the 2.4 GHz range.
- 7. Best Performance**
With two integrated batteries, the SmartIntego lock cylinder and the SmartIntego SmartHandle in wireless online operation provide up to 80,000 activations and five years on standby - up to 50,000 activations and six years in standby mode in a Virtual CardNetwork. This gives years of operation without changing batteries.
The new SmartHandle AX with its integrated batteries in wireless online-operation even provides up to 180,000 operations and up to 9 years in stand-by mode.
- 8. Variety of types for all uses**
Our SmartHandle is available in Europrofile, SwissRound and Scandinavian Oval design. There is also a Scandinavian Round version of the digital locking cylinder.
- 9. Perfectly formed to the finest detail**
Good things should be beautiful too: The SmartIntego lock cylinder and the SmartIntego SmartHandle have won many prestigious design awards.

THE PERFECT SOLUTION FOR INTEGRATED ACCESS CONTROL.



SmartIntego lock cylinders, SmartHandle, PinCode-keyboards, padlocks and GatewayNode – the components of SmartIntego can be easily integrated into complex security systems.

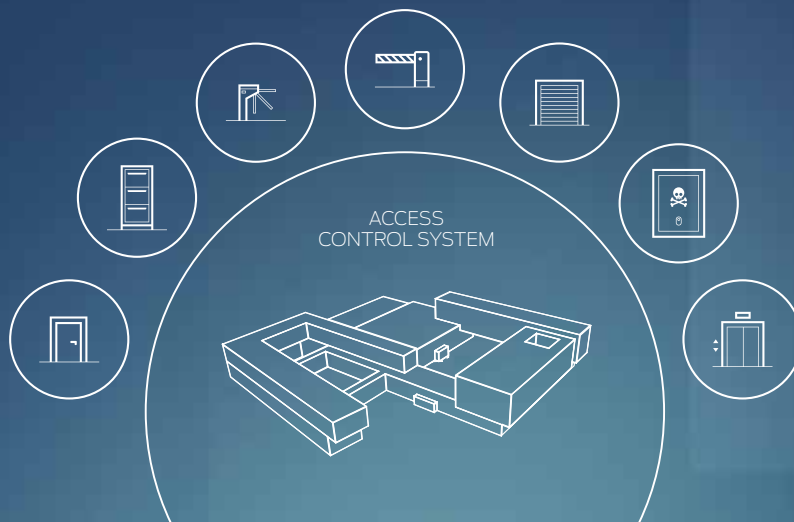

SmartIntego Locking Cylinder



SmartIntego SmartHandle AX



SmartIntego SmartHandle



SmartIntego Padlock



SmartIntego PIN code



SmartIntego GatewayNode

With its high-performance communications protocols, SmartIntego can be seamlessly incorporated into existing control systems for building security technology. The auto-configuration of system components in the SmartIntego Manager ensures that there is far less work involved in component integration compared to other systems.

The scope of services and features match high expectations which building operators have of innovation leaders for digital locking and access control systems. One advantage of the system is its 868-MHz technology, which ensures wide, interference-free ranges in the radio network.

The SmartIntego product range, consisting of lock cylinders, SmartHandles and padlocks, deals with the transfer standards of all common card formats like MIFARE® Classic, MIFARE® DESFire®/ EV1/EV2 and for Wireless Online also UID (card serial number) according to ISO 14443 (e.g. MIFARE®, Legic® Advant, HID® SEOS).

In SmartIntego, SimonsVoss offers a solution with components which have proven their worth a thousand times over in practical use. These components excel thanks to their German-made quality and excellent design. Unique functions also ensure optimum security – for people, for investment and for the future.

DIGITAL LOCKING WITH SMARTINTEGO – HIGHLIGHTS

// State-of-the-Art

Integration of electronic instead of mechanical access control in existing building systems based on flexible interfaces, high-performance protocols and open system design.

// Use of existing IT infrastructure

SmartIntego can also be integrated into heterogeneous IT infrastructures via existing user interfaces at no great cost without additional complicated connections through additional databases or software.

// Simple, cable-free installation

Cables do not need to be installed or connected. Standard button cells ensure that cylinders and fittings do not depend on an external power supply.

// Variety

Large range of different cylinders enables solutions for nearly every application.

// Flexibility

Respond flexibly to every situation on site: The SmartHandle AX is adaptable to door thickness, centring distance and square spindle.

// Snap-in fitting

Unique fitting technology for attaching SmartHandles without drilling holes in the door. This brings particular benefits for rental property and fire doors, where drilling is forbidden.

// Greatest possible security

Events logged to record which users have gained access to a particular place at specific times. Lost ID media instantly blocked and unauthorised key copying eliminated (3D printing).

// Unlimited flexibility

Very simple processes thanks to interfaces between HR department and locking system management. Problem-free handling of modifications to the organisation and room use in places where employees change on a frequent basis. ID media can be issued with limited validity for users such as visitors or maintenance staff etc.

// Low costs for administration and training

Intuitive operation using existing software ensures that the time and expense for administration and training are kept to a minimum.



DIGITAL LOCKING CYLINDER SMART INTEGO

Multifunctional and easy to assemble, even as a retrofit.

The SimonsVoss SmartIntego Digital Locking Cylinder provides service exactly as required at each point throughout the building – in entrance areas and interiors or on doors to a guest room, hallway, laboratory, archive, server room or basement. Its intelligent internal components and wide range of different designs, such as those for anti-panic and fire doors, provide precisely matched solutions for virtually any application.

In addition to a high security standard and remarkable flexibility, the SmartIntego Digital Locking Cylinder is also extremely easy to fit. It is installed in minutes with no need for any wiring or drilling. Standard button cells reliably ensure up to 80,000 locking operations in an online network. An average battery life of up to five years can be expected in standby mode. Like other SmartIntego components, the locking cylinder is maintenance-free for many years.

The digital locking cylinder matches its surroundings with a beautiful, timeless design available in different versions, such as Euro Profile, Scandinavian Round or Oval, and Swiss Round.



DIGITAL EURO PROFILE DOUBLE THUMB-TURN CYLINDER SMART INTEGO– COMFORT



Digital locking cylinder with enclosed electronics assembly as per DIN 18252 / DIN EN 15684 / EN 1303

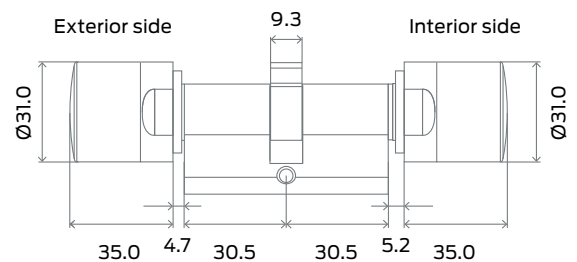

Measurements shown in mm

- :: Inner side is permanently engaged
- :: Wireless Online: MIFARE® Classic, MIFARE Plus®, MIFARE® DESFire® / EV1/EV2, UID (card serial number) as per ISO 14443 (z.B. MIFARE®, Legic® Advant, HID® SEOS), and Calypso Serial number and 7816-4 elementary file
- :: Virtual CardNetwork: MIFARE® Classic or MIFARE® DESFire® / EV1/EV2
- :: Versions with IP66 protection type
- :: Online versions: network-ready in wireless-online on 868 MHz
- :: Offline version: for use in a virtual network (Virtual Card Network)

Direct networking or virtual networking, worldwide cable-free networking in the SimonsVoss-SmartIntego System.

// TECHNICAL DATA

- :: Standard Euro Profile cylinder as per DIN 18252 / EN1303 / DIN EN 15684
- :: Thumb-turn 31 mm in diameter
- :: Basic construction length 30–30 mm (external/internal dimension)
- :: Overall length: up to 140 mm (max. 90 mm on one side), special lengths on request
- :: Protection type: IP 54, Version .WP: IP 66
- :: Battery type: 2 x lithium CR2450 3V Lithium
- :: Battery lifetime:
 - Wireless Online: up to 80,000 closures
 - Virtual Card Network: up to 50,000 closures
 - Wireless Online Stand-by: up to 5 years
 - Virtual Card Network Stand-by: up to 5 years
- :: Temperature range: operation –25 °C to +65 °C
- :: Audible feedback signal from a buzzer
- :: Visual feedback signal from blue/red LED

DIGITAL EURO PROFILE DOUBLE THUMB-TURN CYLINDER SMART INTEGO– COMFORT

// WIRELESS ONLINE (868 MHZ)

- :: Reads 5 different card set-ups
- :: Opened after release by access control system (short release interval) with variable time settings
- :: Permanent release (on/off) with timer function
- :: Office mode with timer function
- :: White List function with up to 250 offline cards
- :: Recording of accesses even in the event of network failure
- :: Transmission of battery status and QoS (quality of signal)
- :: Configurable "keep alive" event
- :: Construction White List function with up to 128 cards
- :: 'Integrator lock'
- :: Auto-configuration via SmartIntego Manager (in TCP/IP GatewayNode models only)

// VIRTUAL CARD NETWORK

- :: Issue of authorisations (access) based on doors areas, groups and exception functions
- :: Battery status
- :: Office mode with "timer" function
- :: Physical access lists
- :: Time budget/ activation and expiration date
- :: Data deletion on online terminal
- :: Initial programming possible using access control manufacturer's online reader
- :: Time profiles on the card
- :: Data transmission secured during writing and read procedure

// PRODUCT VERSIONS

Description	WIRELESS ONLINE Order code	VIRTUAL CARD NETWORK Order code
Digital Euro Profile Double Thumb-Turn Cylinder – SI -Comfort Installation length 30–30 mm, stainless steel design, internal power supply, thumb-turn on both sides; can be operated from the outside with SmartCards/SmartTags; no medium required to operate from the inner side; no wiring necessary	SI.Z4.30-30.MI.CO	SI.Z4.30-30.M.CO
Brass version	.MS	.MS
Waterproof version, protection type IP 66. For use in exterior doors and doors which are exposed to heavy splashing water. CO.WP cylinders with installation length from 30–30 mm, Note: Only the electronic thumb-turn is sealed for installation length 30–30 mm, for AP2, for MR.WP and for half cylinders.	.WP	.WP
INSTALLATION LENGTHS (all length specifications: external – internal)		
Overall length from 65 mm to 80 mm	z. B. SI.Z4.40-40.MI.CO	z. B. SI.Z4.40-40.M.CO
Overall length over 85mm to 100 mm	z. B. SI.Z4.40-60.MI.CO	z. B. SI.Z4.40-60.M.CO
Overall length over 100 mm up to max. 140 mm (max. 90 mm on one side)	z. B. SI.Z4.65-75.MI.CO	z. B. SI.Z4.65-75.M.CO
Overall length over 140 mm or over 90 mm on one side	on request	on request

DIGITAL EURO PROFILE DOUBLE THUMB-TURN CYLINDER SMART INTEGO – FD



Digital locking cylinder – SI with enclosed electronics assembly
as per DIN 18252 / DIN EN 15684 / EN 1303

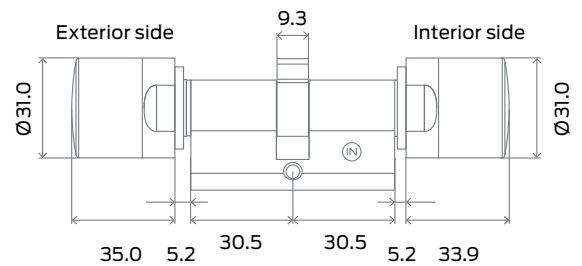

Measurements shown in mm

- :: Freely rotating on both sides – Reader internal and outside
- :: Wireless Online: MIFARE® Classic, MIFARE Plus®, MIFARE® DESFire® / EV1/EV2, UID (card serial number) as per ISO 14443 (e.g. MIFARE®, Legic® Advant, HID® SEOS), and Calypso Serial number and 7816-4 elementary file
- :: Versions with IP66 protection type
- :: Online versions: network-ready in wireless-online on 868 MHz
- :: SKG certified for Wireless online version with a reader on both sides (.BL) available as an option

// TECHNICAL DATA

- :: Digital Euro Profile Cylinder as per DIN 18252 / EN1303 / DIN EN 15684, stainless steel design, freely rotating on both sides
- :: Thumb-turn 31 mm in diameter
- :: Basic construction length 30-30 mm (external/internal dimension)
- :: Overall length: up to 140 mm (max. 90 mm on one side), special lengths on request
- :: Protection type: IP 54, Version .WP: IP 66
- :: Battery type: 4 x Lithium CR2450 3V Lithium
- :: Battery lifetime :
 - Wireless Online: up to 80,000 closures
 - Wireless Online Stand-by: up to 5 years
- :: Temperature range: operation –25 °C to +65 °C
- :: Audible feedback signal from a buzzer
- :: Visual feedback signal from blue/red LED

DIGITAL EURO PROFILE
DOUBLE THUMB-TURN CYLINDER
SMART INTEGO – FD

// WIRELESS ONLINE (868 MHZ)

- :: Reads 5 different card set-ups
- :: Opened after release by access control system (short release interval) with variable time settings
- :: Permanent release (on/off) with timer function
- :: Office mode with timer function
- :: White List function with up to 250 offline cards
- :: Recording of accesses even in the event of network failure
- :: Transmission of battery status and QoS (quality of signal)
- :: Configurable "keep alive" event
- :: Construction White List function with up to 128 cards
- :: 'Integrator lock'
- :: Auto-configuration via SmartIntego Manager (in TCP/IP GatewayNode models only)

// PRODUCT VERSIONS

Description	WIRELESS ONLINE Order code	VIRTUAL CARD NETWORK Order code
Digital Euro Profile Double Thumb-Turn Cylinder SI – FD Installation length 30–30 mm, stainless steel design, internal power supply, freely rotating on both sides; can be operated on the internal and outside with SmartCards/SmartTags; no wiring necessary	SI.Z4.30-30.MI.FD	
Brass version	.MS	
Multi-point lock version for use in doors with multi-point locks	.MR	
Weatherproof version, protection type IP 66. For use in exterior doors and doors which are exposed to heavy splashing water. FD.WP from installation length 30–35 mm. Only the electronic thumb-turn is sealed for installation length 30–30 mm, for AP2, for MR.WP and for half cylinders.	.WP	
Version with SKG approval SKG***	.SKG	
INSTALLATION LENGTHS (all length specifications: external – internal)		
Overall length from 65 mm to 80 mm	z. B. SI.Z4.40-40.MI.FD	
Overall length over 85 mm to 100 mm	z. B. SI.Z4.40-60.MI.FD	
Overall length over 100 mm up to max. 140 mm (max. 90 mm on one side)	z. B. SI.Z4.65-75.MI.FD	
Overall length over 140 mm or over 90 mm on one side	on request	

DIGITAL EURO PROFILE DOUBLE THUMB-TURN CYLINDER SMART INTEGO –ANTI-PANIC



Digital Locking Cylinder – SI with an enclosed electronics assembly as per DIN 18252 / DIN EN 15684 / EN 1303 for fitting into escape doors as per EN 179 and EN1125.

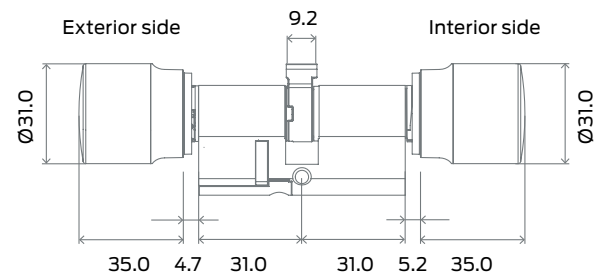

Measurements shown in mm

- ⚡ Strong spring-back mechanism
- ⚡ Wireless Online: MIFARE® Classic, MIFARE Plus®, MIFARE® DESFire® / EV1/EV2, UID (card serial number) as per ISO 14443 (z.B. MIFARE®, Legic® Advant, HID® SEOS), and Calypso Serial number and 7816-4 elementary file
- ⚡ Virtual CardNetwork: MIFARE® Classic or MIFARE® DESFire® / EV1/EV2
- ⚡ Option with free rotation and reader on both sides – Reader unit internal and outside ("BL" version with reader on both sides is not supported in Virtual CardNetwork)
- ⚡ Versions with IP66 protection type
- ⚡ Online models: network-ready on 868 MHz
- ⚡ Offline version: for use in a virtual network (Virtual Card Network)
- ⚡ SKG certified for Wireless online version with a reader on both sides (.BL) available as an option

Direct networking or virtual networking, worldwide cable-free networking in the SimonsVoss-SmartIntego System.

// TECHNICAL DATA

- ⚡ Digital Euro Profile Anti-Panic Cylinder as per DIN 18252 / EN 1303 / DIN EN 15684
- ⚡ Thumb-turn 31 mm in diameter
- ⚡ Basic construction length 30–30 mm (external/internal dimension)
- ⚡ Overall length: up to 140 mm (max. 90 mm on one side), special lengths on request
- ⚡ Protection type: IP 54, Version .WP: IP 66 (Electronic button)
- ⚡ Battery type: 2 x lithium CR2450 3V Lithium
- ⚡ Battery lifetime:
 - Wireless Online: up to 80,000 closures
 - Virtual Card Network: up to 50,000 closures
 - Wireless Online Stand-by: up to 5 years
 - Virtual Card Network Stand-by: up to 5 years
- ⚡ Temperature range: operation –25 °C to +65 °C
- ⚡ Audible feedback signal from a buzzer
- ⚡ Visual feedback signal from blue/red LED

DIGITAL EURO PROFILE DOUBLE THUMB-TURN CYLINDER SMART INTEGO –ANTI-PANIC

// WIRELESS ONLINE (868 MHZ)

- ⚡ Reads 5 different card set-ups
- ⚡ Opened after release by access control system (short release interval) with variable time settings
- ⚡ Permanent release (on/off) with timer function
- ⚡ Office mode with timer function
- ⚡ White List function with up to 250 offline cards
- ⚡ Recording of accesses even in the event of network failure
- ⚡ Transmission of battery status and QoS (quality of signal)
- ⚡ Configurable "keep alive" event
- ⚡ Construction White List function with up to 128 cards
- ⚡ 'Integrator lock'
- ⚡ Auto-configuration via SmartIntego Manager (in TCP/IP GatewayNode models only)

// VIRTUAL CARD NETWORK

- ⚡ Issue of authorisations (access) based on doors areas, groups and exception functions
- ⚡ Battery status
- ⚡ Office mode with "timer" function
- ⚡ Physical access lists
- ⚡ Time budget / activation and expiration date
- ⚡ Data deletion on online terminal
- ⚡ Initial programming possible using access control manufacturer's online reader
- ⚡ Time profiles on the card
- ⚡ Data transmission secured during writing and read procedure

// PRODUCT VERSIONS

Description	WIRELESS ONLINE Order code	VIRTUAL CARD NETWORK Order code
Digital Euro Profile Double Thumb-Turn Cylinder SI – Anti-Panic – FD Installation length 30–30 mm, for use in anti-panic locks; stainless steel design, freely rotating on both sides, internal power supply; thumb-turn on both sides; can be operated from the outside with SmartCards/SmartTags; no wiring required	SI.Z4.30-30.MI.AP2.FD	SI.Z4.30-30.M.AP2.FD
Digital Euro Profile Double Thumb-Turn Cylinder SI – Anti-Panic – FD Installation length 30–30 mm, for use in anti-panic locking devices stainless steel design, freely rotating on both sides, internal power supply, thumb-turn on both sides; can be operated from the outside with SmartCards/SmartTags; no wiring required	SI.Z4.30-30.MI.AP2.BL	
Brass version	.MS	.MS
Weatherproof version, protection type IP 66. For use in exterior doors and doors which are exposed to heavy splashing water. AP2-cylinder from installation length 30–35mm. Note: Only the electronic thumb-turn is sealed for installation length 30–30 mm, for AP2, for MR.WP and for half cylinders.	.WP	.WP
Version without interior thumb turn, for AP2-cylinder, not available in combination with SKG, interior dimension is always 30 mm	.OK	.OK
Version with SKG approval SKG*** (can only be supplied in conjunction with AP2.BL)	.SKG	
INSTALLATION LENGTHS (all length specifications: external – internal)		
Overall length from 65 mm to 80 mm	z. B. SI.Z4.40-40.MI.AP2.FD	z. B. SI.Z4.40-40.M.AP2.FD
Overall length over 85 mm to 100 mm	z. B. SI.Z4.40-60.MI.AP2.FD	z. B. SI.Z4.40-60.M.AP2.FD
Overall length over 100 mm up to max. 140 mm (max. 90 mm on one side)	z. B. SI.Z4.65-75.MI.AP2.FD	z. B. SI.Z4.65-75.M.AP2.FD
Overall length over 140 mm or over 90 mm on one side	on request	on request

DIGITAL EURO PROFILE HALF CYLINDER – SMART INTEGO



Digital half cylinder with an enclosed electronics assembly as per DIN 18252 / DIN EN 15684 / EN 1303 for special applications, such as use on garage doors or in lockers:

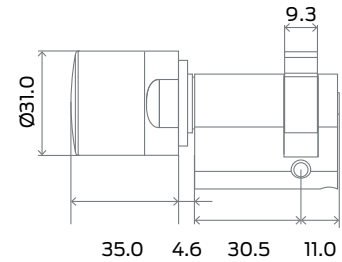

Measurements shown in mm

- ⌘ Wireless Online: MIFARE® Classic, MIFARE Plus®, MIFARE® DESFire® / EV1/EV2, UID (card serial number) as per ISO 14443 (z.B. MIFARE®, Legic® Advant, HID® SEOS), and Calypso Serial number and 7816-4 elementary file
- ⌘ Virtual CardNetwork: MIFARE® Classic or MIFARE® DESFire® / EV1/EV2
- ⌘ Versions with IP66 protection type
- ⌘ Online versions: network-ready in wireless-online on 868 MHz
- ⌘ Offline version: for use in a virtual network (Virtual Card Network)

Direct networking or virtual networking, worldwide cable-free networking in the SimonsVoss-SmartIntego System.

// TECHNICAL DATA

- ⌘ Digital Euro Profile Half Cylinder as per DIN 18252 / EN 1303 / DIN EN 15684
- ⌘ Thumb-turn 31 mm in diameter
- ⌘ Basic installation length 30-30 mm (external/internal dimension)
- ⌘ Overall length: up to 140 mm (max. 90 mm on one side), special lengths on request
- ⌘ Protection type: IP 54, Version .WP: IP 66 (Electronic button)
- ⌘ Battery type: 2 x lithium CR2450 3V Lithium
- ⌘ Battery lifetime:
 - Wireless Online: up to 80,000 closures
 - Virtual Card Network: up to 50,000 closures
 - Wireless Online Stand-by: up to 5 years
 - Virtual Card Network Stand-by: up to 5 years
- ⌘ Temperature range: operation -25 °C to +65 °C
- ⌘ Audible feedback signal from a buzzer
- ⌘ Visual feedback signal from blue/red LED

DIGITAL EURO PROFILE HALF CYLINDER – SMART INTEGO

// WIRELESS ONLINE (868 MHZ)

- :: Reads 5 different card set-ups
- :: Opened after release by access control system (short release interval) with variable time settings
- :: Permanent release (on/off) with timer function
- :: Office mode with timer function
- :: White List function with up to 250 offline cards
- :: Recording of accesses even in the event of network failure
- :: Transmission of battery status and QoS (quality of signal)
- :: Configurable "keep alive" event
- :: Construction White List function with up to 128 cards
- :: 'Integrator lock'
- :: Auto-configuration via SmartIntego Manager (in TCP/IP GatewayNode models only)

// VIRTUAL CARD NETWORK

- :: Issue of authorisations (access) based on doors areas, groups and exception functions
- :: Battery status
- :: Office mode with "timer" function
- :: Physical access lists
- :: Time budget/ activation and expiration date
- :: Data deletion on online terminal
- :: Initial programming possible using access control manufacturer's online reader
- :: Time profiles on the card
- :: Data transmission secured during writing and read procedure

// PRODUCT VERSIONS

Description	WIRELESS ONLINE Order code	VIRTUAL CARD NETWORK Order code
Digital Euro Profile Half Cylinder – SI Installation length 30–10 mm, stainless steel design; thumb-turn cannot be detached; internal power supply; can be operated on the outside with SmartCards/SmartTags; no wiring necessary.	SI.Z4.30-10.MI.HZ	SI.Z4.30-10.M.HZ
Brass version	.MS	.MS
Version with detachable thumb-turn	.DK	.DK
Multi-point lock version for use in doors with multi-point locks	.MR	.MR
Weatherproof version, protection type IP 66. For use in exterior doors and doors which are exposed to heavy splashing water. Note: Only the electronic thumb-turn is sealed for installation length 30–30 mm, for AP2, for MR.WP and for half cylinders.	.WP	.WP
Version with self-locking; not in combination with MR, MS, DK and WP	.SL	.SL
INSTALLATION LENGTHS (all length specifications: external – internal)		
Overall length from 45 mm to 70 mm	z. B. SI.Z4.60-10.MI.HZ	z. B. SI.Z4.60-10.M.HZ
Overall length from 75 mm to 100 mm (max. 90 mm on one side)	z. B. SI.Z4.80-10.MI.HZ	z. B. SI.Z4.80-10.M.HZ
Overall length over 100 mm	on request	on request

DIGITAL SCANDINAVIAN OVAL CYLINDER – SMART INTEGO



Digital Locking Cylinder – SI with an enclosed electronics assembly as per DIN EN 15684 / EN 1303 for fitting into doors with a Scandinavian Oval profile.

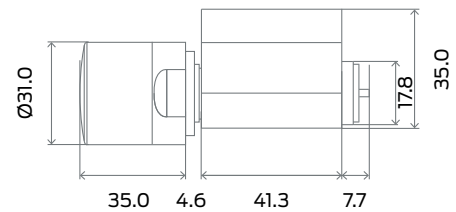

Measurements shown in mm

- ∴ Wireless Online: MIFARE® Classic, MIFARE Plus®, MIFARE® DESFire® / EV1/EV2, UID (card serial number) as per ISO 14443 (e.g. MIFARE®, Legic® Advant, HID® SEOS), and Calypso Serial number and 7816-4 elementary file
- ∴ Virtual Card Network: MIFARE® Classic or MIFARE® DESFire® / EV1/EV2
- ∴ Versions with IP66 protection type
- ∴ Online versions: network-ready in wireless-online on 868 MHz
- ∴ Offline version: for use in a virtual network (Virtual Card Network)

Direct networking or virtual networking, worldwide cable-free networking in the SimonsVoss-SmartIntego System.

// TECHNICAL DATA

- ∴ Digital Scandinavian Oval Cylinder
- ∴ Thumb-turn 31 mm in diameter
- ∴ Basic installation length 30–30 mm (external/internal dimension)
- ∴ Overall length: cam extension set to 6.35 mm or 7.45 mm (width); extension adapter can be trimmed on site
- ∴ Protection type: IP 54, Version .WP: IP 66
- ∴ Battery type: 2 x lithium CR2450 3V Lithium
- ∴ Battery lifetime:
 - Wireless Online: up to 80,000 closures
 - Virtual Card Network: up to 50,000 closures
 - Wireless Online Stand-by: up to 5 years
 - Virtual Card Network Stand-by: up to 5 years
- ∴ Temperature range: operation –25 °C to +65 °C
- ∴ Audible feedback signal from a buzzer
- ∴ Visual feedback signal from blue/red LED

DIGITAL SCANDINAVIAN OVAL CYLINDER – SMART INTEGO

// WIRELESS ONLINE (868 MHZ)

- :: Reads 5 different card set-ups
- :: Opened after release by access control system (short release interval) with variable time settings
- :: Permanent release (on/off) with timer function
- :: Office mode with timer function
- :: White List function with up to 250 offline cards
- :: Recording of accesses even in the event of network failure
- :: Transmission of battery status and QoS (quality of signal)
- :: Configurable "keep alive" event
- :: Construction White List function with up to 128 cards
- :: 'Integrator lock'
- :: Auto-configuration via SmartIntego Manager (in TCP/IP GatewayNode models only)

// VIRTUAL CARD NETWORK

- :: Issue of authorisations (access) based on doors areas, groups and exception functions
- :: Battery status
- :: Office mode with "timer" function
- :: Physical access lists
- :: Time budget / activation and expiration date
- :: Data deletion on online terminal
- :: Initial programming possible using access control manufacturer's online reader
- :: Time profiles on the card
- :: Data transmission secured during writing and read procedure

// PRODUCT VERSIONS

Description	WIRELESS ONLINE Order code	VIRTUAL CARD NETWORK Order code
Digital Scandinavian Oval Cylinder – SI Installation length 41.3 mm, stainless steel design, internal power supply, operated from outside with SmartCards/SmartTags; no wiring required	SI.Z4.SO.A40.MI	SI.Z4.SO.A40.M
Brass version	.MS	.MS
Waterproof version, protection type IP 66. For use in exterior doors and doors which are exposed to heavy splashing water.	.WP	.WP
SO cylinder extension set. The set allows you to extend the Scandinavian cylinder cam by up to 50 mm (6.35 mm wide), Contents: 5 sets	Z4.SO.EXT.5	Z4.SO.EXT.5
SO cylinder extension set. The set allows you to extend the Scandinavian cylinder cam by up to 50 mm (6.35 mm wide), Contents: 5 sets	Z4.SO.EXT.745.5	Z4.SO.EXT.745.5

DIGITAL SCANDINAVIAN ROUND CYLINDER – SMART INTEGO



Digital Locking Cylinder – SI with an enclosed electronics assembly as per DIN EN 15684 / EN 1303 for fitting into doors with a Scandinavian Round profile:

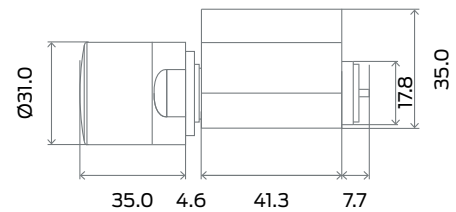

Measurements shown in mm

- ∴ Wireless Online: MIFARE® Classic, MIFARE Plus®, MIFARE® DESFire® / EV1/EV2, UID (card serial number) as per ISO 14443 (e.g. MIFARE®, Legic® Advant, HID® SEOS), and Calypso Serial number and 7816-4 elementary file
- ∴ Virtual CardNetwork: MIFARE® Classic or MIFARE® DESFire® / EV1/EV2
- ∴ Versions with IP66 protection type
- ∴ Online versions: network-ready in wireless-online on 868 MHz
- ∴ Offline version: for use in a virtual network (Virtual Card Network)

Direct networking or virtual networking, worldwide cable-free networking in the SimonsVoss-SmartIntego System.

// TECHNICAL DATA

- ∴ Digital Scandinavian Round Cylinder
- ∴ Thumb-turn 31 mm in diameter
- ∴ Basic installation length 30-30 mm (external/internal dimension)
- ∴ Overall length: cam extension set to 6.35 mm or 7.45 mm (width); extension adapter can be trimmed on site
- ∴ Protection type: IP 54, Version .WP: IP 66
- ∴ Battery type: 2 x lithium CR2450 3V Lithium
- ∴ Battery lifetime:
 - Wireless Online: up to 80,000 closures
 - Virtual Card Network: up to 50,000 closures
 - Wireless Online Stand-by: up to 5 years
 - Virtual Card Network Stand-by: up to 5 years
- ∴ Temperature range: operation –25 °C to +65 °C
- ∴ Audible feedback signal from a buzzer
- ∴ Visual feedback signal from blue/red LED

DIGITAL SCANDINAVIAN ROUND CYLINDER – SMART INTEGO

// WIRELESS ONLINE (868 MHZ)

- :: Reads 5 different card set-ups
- :: Opened after release by access control system (short release interval) with variable time settings
- :: Permanent release (on/off) with timer function
- :: Office mode with timer function
- :: White List function with up to 250 offline cards
- :: Recording of accesses even in the event of network failure
- :: Transmission of battery status and QoS (quality of signal)
- :: Configurable "keep alive" event
- :: Construction White List function with up to 128 cards
- :: 'Integrator lock'
- :: Auto-configuration via SmartIntego Manager (in TCP/IP GatewayNode models only)

// VIRTUAL CARD NETWORK

- :: Issue of authorisations (access) based on doors areas, groups and exception functions
- :: Battery status
- :: Office mode with "timer" function
- :: Physical access lists
- :: Time budget / activation and expiration date
- :: Data deletion on online terminal
- :: Initial programming possible using access control manufacturer's online reader
- :: Time profiles on the card
- :: Data transmission secured during writing and read procedure

// PRODUCT VERSIONS

Description	WIRELESS ONLINE Order code	VIRTUAL CARD NETWORK Order code
Digital Scandinavian Round Cylinder – SI Installation length 41.3 mm, stainless steel design, internal power supply, operated from outside with SmartCards/SmartTags; no wiring required	SI.Z4.RS.A40.MI	SI.Z4.RS.A40.M
Brass version	.MS	.MS
Waterproof version, protection type IP 66. For use in exterior doors and doors which are exposed to heavy splashing water.	.WP	.WP
SO cylinder extension set. The set allows you to extend the Scandinavian cylinder cam by up to 50 mm (6.35 mm wide), Contents: 5 sets	Z4.SO.EXT.5	Z4.SO.EXT.5
SO cylinder extension set. The set allows you to extend the Scandinavian cylinder cam by up to 50 mm (6.35 mm wide), Contents: 5 sets	Z4.SO.EXT.745.5	Z4.SO.EXT.745.5

DIGITAL SWISS ROUND DOUBLE THUMB-TURN CYLINDER – SMART INTEGO



Digital Locking Cylinder – SI with an enclosed electronics assembly as per DIN EN 15684 / EN 1303 for fitting into doors with a Swiss Round profile.

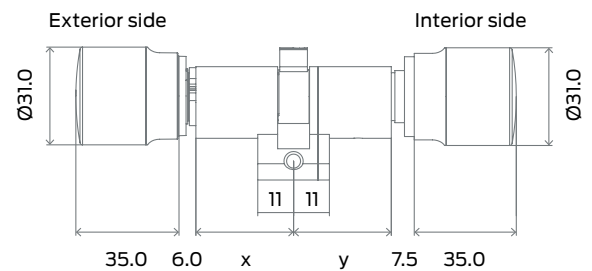

Measurements shown in mm

- ∴ Wireless Online: MIFARE® Classic, MIFARE Plus®, MIFARE® DESFire® / EV1/EV2, UID (card serial number) as per ISO 14443 (z.B. MIFARE®, Legic® Advant, HID® SEOS), and Calypso Serial number and 7816-4 elementary file
- ∴ Virtual CardNetwork: MIFARE® Classic or MIFARE® DESFire® / EV1/EV2
- ∴ Versions with IP66 protection type
- ∴ Online versions: network-ready in wireless-online on 868 MHz
- ∴ Offline version: for use in a virtual network (Virtual Card Network)

Direct networking or virtual networking, worldwide cable-free networking in the SimonsVoss-SmartIntego System.

// TECHNICAL DATA

- ∴ Digital Swiss Round Double Thumb-Turn Cylinder – Comfort, internal thumb-turn can be operated without SmartCard
- ∴ Thumb-turn 31 mm in diameter
- ∴ Basic construction length 30–30 mm (external/internal dimension)
- ∴ Overall length: up to 140 mm (max. 90 mm on one side), special lengths on request
- ∴ Protection type: IP 54, Version .WP: IP 66 (Electronic button)
- ∴ Battery type: 2 x lithium CR2450 3V Lithium
- ∴ Battery lifetime:
 - Wireless Online: up to 80,000 closures
 - Virtual Card Network: up to 50,000 closures
 - Wireless Online Stand-by: up to 5 years
 - Virtual Card Network Stand-by: up to 5 years
- ∴ Temperature range: operation –25 °C to +65 °C
- ∴ Audible feedback signal from a buzzer
- ∴ Visual feedback signal from blue/red LED

DIGITAL SWISS ROUND DOUBLE THUMB TURN CYLINDER – SMART INTEGO

// WIRELESS ONLINE (868 MHZ)

- :: Reads 5 different card set-ups
- :: Opened after release by access control system (short release interval) with variable time settings
- :: Permanent release (on/off) with timer function
- :: Office mode with timer function
- :: White List function with up to 250 offline cards
- :: Recording of accesses even in the event of network failure
- :: Transmission of battery status and QoS (quality of signal)
- :: Configurable "keep alive" event
- :: Construction White List function with up to 128 cards
- :: 'Integrator lock'
- :: Auto-configuration via SmartIntego Manager (in TCP/IP Gateway Node models only)

// VIRTUAL CARD NETWORK

- :: Issue of authorisations (access) based on doors areas, groups and exception functions
- :: Battery status
- :: Office mode with "timer" function
- :: Physical access lists
- :: Time budget/ activation and expiration date
- :: Data deletion on online terminal
- :: Initial programming possible using access control manufacturer's online reader
- :: Time profiles on the card
- :: Data transmission secured during writing and read procedure

// PRODUCT VERSIONS

Description	WIRELESS ONLINE Order code	VIRTUAL CARD NETWORK Order code
Digital Swiss Round Double Thumb-Turn Cylinder – SI Installation length 30–30 mm, digital comfort cylinder, stainless steel design, internal power supply, thumb-turn on both sides, can be operated from the outside with SmartCards/SmartTags; no medium required to operate from the inner side, no wiring necessary	SI.Z4.SR.30-30.MI.CO	SI.Z4.SR.30-30.M.CO
Brass version	.MS	.MS
Waterproof version with IP 66 protection type(electronic thumb turn). For use in exterior doors and doors exposed to heavy water spray.	.WP	.WP
INSTALLATION LENGTHS (all length specifications: external – internal)		
Overall length from 65 mm to 80 mm	z. B. SI.Z4.SR.40-40.MI.CO	z. B. SI.Z4.SR.40-40.M.CO
Overall length over 85 mm to 100 mm	z. B. SI.Z4.SR.40-60.MI.CO	z. B. SI.Z4.SR.40-60.M.CO
Overall length over 100 mm up to max. 140 mm (max. 90 mm on one side)	z. B. SI.Z4.SR.65-75.MI.CO	z. B. SI.Z4.SR.65-75.M.CO
Overall length over 140 mm or over 90 mm on one side	on request	on request

DIGITAL SWISS ROUND HALF CYLINDER – SMART INTEGO

Digital Half Cylinder – SI with an enclosed electronics assembly as per DIN EN 15684 / EN 1303 for special applications, such as garage doors or in lockers.

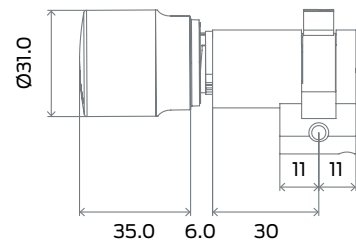

Measurements shown in mm

- ⚡ Wireless Online: MIFARE® Classic, MIFARE Plus®, MIFARE® DESFire® / EV1/EV2, UID (card serial number) as per ISO 14443 (e.g. MIFARE®, Legic® Advant, HID® SEOS), and Calypso Serial number and 7816-4 elementary file
- ⚡ Virtual CardNetwork: MIFARE® Classic or MIFARE® DESFire® / EV1/EV2
- ⚡ Versions with IP66 protection type
- ⚡ Online versions: network-ready in wireless-online on 868 MHz
- ⚡ Offline version: for use in a virtual network (Virtual Card Network)

Direct networking or virtual networking, worldwide cable-free networking in the SimonsVoss-SmartIntego System.

// TECHNICAL DATA

- ⚡ Digital Swiss Round Half Cylinder – SI
- ⚡ Thumb-turn 31 mm in diameter
- ⚡ Basic installation length 30–30 mm (external/internal dimension)
- ⚡ Overall length: up to 140 mm (max. 90 mm on one side), special lengths on request
- ⚡ Protection type: IP 54, Version .WP: IP 66 (Electronic button)
- ⚡ Battery type: 2 x lithium CR2450 3V Lithium
- ⚡ Battery lifetime:
 - Wireless Online: up to 80,000 closures
 - Virtual Card Network: up to 50,000 closures
 - Wireless Online Stand-by: up to 5 years
 - Virtual Card Network Stand-by: up to 5 years
- ⚡ Temperature range: operation –25 °C to +65 °C
- ⚡ Audible feedback signal from a buzzer
- ⚡ Visual feedback signal from blue/red LED

DIGITAL SWISS ROUND HALF CYLINDER – SMART INTEGO

// WIRELESS ONLINE (868 MHZ)

- :: Reads 5 different card set-ups
- :: Opened after release by access control system (short release interval) with variable time settings
- :: Permanent release (on/off) with timer function
- :: Office mode with timer function
- :: White List function with up to 250 offline cards
- :: Recording of accesses even in the event of network failure
- :: Transmission of battery status and QoS (quality of signal)
- :: Configurable "keep alive" event
- :: Construction White List function with up to 128 cards
- :: 'Integrator lock'
- :: Auto-configuration via SmartIntego Manager (in TCP/IP Gateway Node models only)

// VIRTUAL CARD NETWORK

- :: Issue of authorisations (access) based on doors areas, groups and exception functions
- :: Battery status
- :: Office mode with "timer" function
- :: Physical access lists
- :: Time budget / activation and expiration date
- :: Data deletion on online terminal
- :: Initial programming possible using access control manufacturer's online reader
- :: Time profiles on the card
- :: Data transmission secured during writing and read procedure

// PRODUCT VERSIONS

Description	WIRELESS ONLINE Order code	VIRTUAL CARD NETWORK Order code
Digital Swiss Round Half Cylinder – SI Installation length 30–10 mm, stainless steel design; thumb-turn can be detached; powered internally; can be operated on the outside with SmartCards/SmartTags; no wiring necessary	SI.Z4.SR.30-10.MI.HZ	SI.Z4.SR.30-10.M.HZ
Brass version	.MS	.MS
Multi-point lock version for use in doors with multi-point locks	.MR	.MR
Waterproof version with IP 66 protection type (electronic thumb turn). For use in exterior doors and doors exposed to heavy water spray.	.WP	.WP
INSTALLATION LENGTHS (all length specifications: external – internal)		
Overall length from 45 mm to 70 mm	z. B. SI.Z4.SR.60-10.MI.HZ	z. B. SI.Z4.SR.60-10.M.HZ
Overall length from 75 mm to 100 mm (max. 90 mm on one side)	z. B. SI.Z4.SR.80-10.MI.HZ	z. B. SI.Z4.SR.80-10.M.HZ
Overall length over 100 mm	on request	on request

SMART INTEGO CYLINDER – ACCESSORIES

// ACCESSORIES

20 plastic discs for multi-point half cylinder	Z4.DISCS
special tool for disassembly and for replacing batteries (button cells) in TN4 cylinders	Z4.KEYS
10 batteries for SmartHandle and TN4-cylinders (Double thumb-turn and half cylinder) (Type: CR2450)	Z4.BAT.SET
2 core extraction protection adapters for freely rotating SC cylinders (except AP2.FD), 8 mm extension	Z4.MP.KA.SET
2 core extraction protection adapters for SI cylinders SKG, 8 mm extension	Z4.MP.KA.SET2



DIGITAL
SMART HANDLE AX
SMART INTEGO



Multi-functional, intelligent and secure

The new SmartIntego SmartHandle AX interior door fitting is the proverbial handle on intelligence. Compact construction, modular structure, attractive design and efficient electronics provide high user comfort.

Multi functional: SmartIntego SmartHandle AX is designed for use on interior doors, tubular frame doors and glass doors . Its modularity allows adjustment of the electronic fitting to door thickness, distances and square shaft in all important door situations. Installation requires no drilling when using the existing fixing holes. The adaptive design allows combination with common handles of well-known manufacturers. There is also flexibility in the area of emergency route security: various manufacturers' panic bars can be used on these.

Intelligent: The integrated Secure Element encrypts data relevant to security. Up to 180,000 operations or 9 years of stand-by function are provided by the capacities of the built-in batteries in Wireless Online mode.



DIGITAL SMART HANDLE AX SMART INTEGO

COMPOSITION OF THE ITEM NO. WITH EXAMPLE:

Identifier for electronic door handle = SV-S2

Profile: A0 = Euro-PZ, standing fitting

A1 = Euro-PZ, suspended fitting for distance 70-79 mm

A2 = Euro-PZ, suspended fitting (long) for distance 70-110 mm

A3 = Euro-PZ, standing fitting for tubular frame doors

A4 = Euro-PZ, standing fitting for panic bar adaptation

B0 = Swiss Round, standing fitting, possibility of mechanical over-locking

B1 = Swiss Round, suspended fitting for distance 70-79 mm

B2 = Swiss Round, suspended fitting (long) for distance 70-110 mm

E0 = Scandinavian Oval, without lock cylinder opening

E1 = Scandinavian Oval, with lock cylinder opening

Exterior rosette: 0 = none 1 = without lock cylinder opening 2 = with lock cylinder opening

Interior rosette: 0 = none 1 = without lock cylinder opening 2 = with lock cylinder opening

Handle versions exterior: 0 = no handle

A = L-shaped R (round, curved)

B = L-shaped G (mitred)

C = U-shaped R (round, curved)

D = U-shaped G (mitred)

L = U shaped R (mitred)

Optional adaptor set for third-party handles

Handle versions interior: 0 = no handle

A = L-shaped R (round, curved)

B = L-shaped G (mitred)

C = U-shaped R (round, curved)

D = U-shaped G (mitred)

L = U shaped R (mitred)

Optional adaptor set for third-party handles

Surface: 1 = silver/black-grey 2 = silver/white 7 = brass/white

Door thickness: S = 38-60 mm

M = 59-80 mm

L = 79-100 mm

X = 100-200 mm

Square shaft: 07 = 7 mm

08 = 8 mm

85 = 8.5 mm

09 = 9 mm

10 = 10mm

Reader technology: M = SmartCards / SmartTags

Options: (multiple response possible)

FH = Approved for fire safety and emergency exit locks

WO = Wireless Online

VCN = Virtual Card Network

PAS = PAS 24

ER = time controlled return function

Panic bar (only for version A4)

P1 = BKS full-leaf door, without sign 92 mm

P2 = BKS full-leaf door, without sign 72 mm

P11 = CISA full leaf door, with sign 72 mm

SI-S2 A0 1 2. A A. 1st M 08. M WO

=SI-S2.A0.12.AA.1.M08.M.WO

DIGITAL SMART HANDLE AX SMART INTEGO



Is it possible to make something good even better? Yes, it is! Our new generation of SmartHandles is consistently based on our users' needs and sets new standards in the process. SimonsVoss introduces a new level of intelligence, security and convenience to doors with the SmartIntego SmartHandle AX thanks to a modular structure, a wide range of versions and innovative functions.

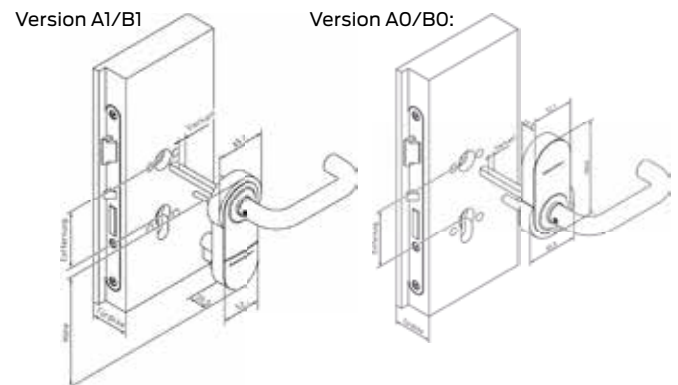

Measurements shown in mm

// ADVANTAGES

- ⌘ Respond flexibly to every situation on site: The SmartHandle AX is adaptable to door thickness, centring distance and square shaft. The handle itself can be mounted on the left or right.
- ⌘ Unusually long battery life (up to 180,000 operations in Wireless Online operation)
- ⌘ Room for beauty: with its characteristic, adaptive design, the AX fitting can be combined with standard handles from renowned manufacturers.
- ⌘ Made in Germany. For us, this goes without saying. The SmartHandle AX has been proven to function continuously for 1 million cycles. (DIN EN 1906)
- ⌘ Operational reliability is decisive. That's why we have invested in mechanical and electronic quality and stability with the AX fitting. For example, the SmartHandle AX features extremely precise handle clearance.
- ⌘ Security in the AX platform: we are only happy when everything is secure. Intrinsic Security Architecture (ISA) with its Secure Element forms the centrepiece of SmartHandle AX.

// TECHNICAL DATA

- ⌘ Versions: Euro Profile, Swiss Round, Scandinavian Oval
- ⌘ Dimensions (W x H x D):
Version A0/B0: 66 x 120 x 21 mm
Version A1/B1: 66 x 140 x 21 mm
Version A2/B2/E0/E1: 65 x 174 x 21 mm
Version A3: 66 x 120 x 26 mm
Version A4: 66 x 120 x 25 mm
- ⌘ Read process:
Wireless Online: MIFARE® Classic, MIFARE® DESFire® / EV1/EV2, UID (card serial number) as per ISO 14443 (e.g. MIFARE®, Legic® Advant, HID® SEOS)
- ⌘ **Virtual Card Network:** MIFARE® Classic, MIFARE® DESFire® / EV1/EV2
- ⌘ Battery type: 4x CR2450 3V Lithium
- ⌘ Battery lifetime:
Wireless Online: up to 180,000 closures
Virtual Card Network: up to 150,000 closures
Wireless Online Stand-by: up to 9 years
Virtual Card Network Stand-by: up to 9 years
- ⌘ Temperature range : operation: -25°C to +50°C
Storage (short-term): -40°C to +50°C
Storage (long-term): 0°C to +30°C
- ⌘ IP-classe: IP40
- ⌘ Feedback: Audible (buzzer), visual (LED – green/red)
- ⌘ Firmware upgradable

DIGITAL SMART HANDLE AX SMART INTEGO

Design your KEYLESS WORLD with two generations of SmartHandle: The SmartHandle and the SmartHandle AX with their convincing design, functionality and compatibility.

Both fittings can be operated with familiar identification media and customised to different door installation types.

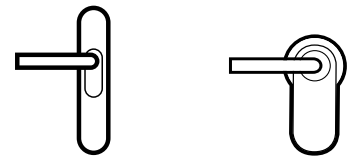

SmartHandle

SmartHandle AX

	SmartHandle	SmartHandle AX
Interior doors		x
Exterior doors	x	
Metal frame doors	x	x
Glass doors		x
Panic bar on interior doors		x

// WIRELESS ONLINE (868 MHZ)

- ⌘ Reads 5 different card set-ups
- ⌘ Opened after release by access control system (short release interval) with variable time settings
- ⌘ Permanent release (on/off) with timer function
- ⌘ Office mode with timer function
- ⌘ White List function with up to 250 offline cards
- ⌘ Recording of accesses even in the event of network failure
- ⌘ Transmission of battery status and QoS (quality of signal)
- ⌘ Configurable "keep alive" event
- ⌘ Construction White List function with up to 128 cards
- ⌘ 'Integrator lock'
- ⌘ Auto-configuration via SmartIntego Manager (in TCP/IP Gateway Node models only)

// VIRTUAL CARD NETWORK

EXPECTED AVAILABILITY
FROM Q2/2020

- ⌘ Issue of authorisations (access) based on doors areas, groups and exception functions
- ⌘ Battery status
- ⌘ Office mode with "timer" function
- ⌘ Physical access lists
- ⌘ Time budget / activation and expiration date
- ⌘ Data deletion on online terminal
- ⌘ Initial programming possible using access control manufacturer's online reader
- ⌘ Time profiles on the card
- ⌘ Data transmission secured during writing and read procedure

// BASIC VERSIONS

Description	Order code
DIGITAL SMART HANDLE AX – SMART INTEGO	
Identifier for electronic door fitting	
SMART INTEGO	SI-S2
PROFILE	
A0 – Euro Profile cylinder, stationary installation, option for mechanical secondary locking device	A0
A1 – Euro Profile cylinder, suspended installation; for a centre distance between 70 and 79 mm	A1
A2 – Euro Profile cylinder, suspended installation; for a centres distance between 70 and 110 mm	A2
A3 – Euro profile cylinder, stationary installation for profile doors (tubular frame doors)	A3
A4 – Euro-PZ, standing fitting for panic bar adaptation	A4
B0 – Swiss Round, stationary installation, option for mechanical secondary locking device	B0
B1 – Swiss Round, suspended installation; for a centres distance between 70 and 79 mm	B1
B2 – Swiss Round, suspended installation; for a centres distance between 70 and 110 mm	B2
E0 – Scandinavian Oval without locking cylinder opening	E0
E1 – Scandinavian Oval with locking cylinder opening	E1

// OPTIONS

Description	Order code
OUTSIDE ESCUTCHEON	
No escutcheon cover	0
Escutcheon cover without locking cylinder opening	1
Escutcheon cover with locking cylinder opening	2
INSIDE ESCUTCHEON	
No escutcheon cover	0
Escutcheon cover without locking cylinder opening	1
Escutcheon cover with locking cylinder opening	2
Silver / black grey	1
Silver / white	2
Brass / white	7

DIGITAL
SMART HANDLE AX
SMART INTEGO

// OPTIONS

Description	Order code
EXTERIOR HANDLE VERSION	
Without handle	0
L-shaped R (rounded)	A
L-shaped G (mitred)	B
U-shaped R (rounded)	C
U-shaped G (mitred)	D
U-Form R (elbowed)	L
HANDLE VERSION INSIDE	
Without handle	0
L-shaped R (rounded)	A
L-shaped G (mitred)	B
U-shaped R (rounded)	C
U-shaped G (mitred)	D
U-Form R (elbowed)	L
SURFACE FINISH	
Silver / black grey	1
Silver / white	2
Brass / white	7



DIGITAL
SMART HANDLE AX
SMART INTEGO

Description	Order code
DOOR THICKNESS	
38 – 60 mm	S
59 – 80 mm	M
79 – 100 mm	L
100 – 200 mm	X
SPINDLE	
7 mm	07
8 mm	08
8.5 mm	85
9 mm (the FH option must be ordered in addition for fire doors and emergency exit devices)	09
10 mm	10
READER TECHNOLOGY	
Permanently engaged for use (without electronics)	0
SmartCards / SmartTags	M
OPTIONS (multiple selection possible)	
Approved for fire-retardant doors and emergency exit devices	FH
Wireless online MIFARE® Classic, MIFARE® DESFire®/ EV1/EV2, UID (card serial number) as per ISO 14443 (e.g. MIFARE®, Legic® Advant, HID® SEOS)	WO
Virtual Card Network MIFARE® Classic, MIFARE® DESFire®/ EV1/EV2	VCN
PAS 24	PAS
Time-controlled return function	ER
PANIC BAR ADAPTATION (only for Version A4)	
BKS full-leaf door, without sign, 92 mm	P1
BKS full-leaf door, without sign, 72 mm	P2
CISA full-leaf door, with sign, 72 mm	P11

EXPECTED AVAILABILITY
FROM Q2/2020

DIGITAL
SMART HANDLE AX
SMART INTEGO

Description	Order code
ACCESSORIES	
Adapter for installing an FSB handle with ASL or AGL fastening type (observe compatibility list)	S2.ADAPTER.FSB
Adapter for installing a GLUTZ handle (observe compatibility list)	S2.ADAPTER.GLUTZ
Inside and exterior handles for retrofit; specify handle variant A, B, C or D and Spindle 7, 8 or 9	S2.LEVER.x.x
Spindle in S, M, L or X length and 7, 8 or 9 mm in diameter, please indicate length and diameter	S2.SQUARE.x.x
Cover for Version A0/B0, black-grey	SI-S2.COVER.0.SG
Cover for Version A0/B0, white	SI-S2.COVER.0.W
Cover for Version A1/B1, black-grey	SI-S2.COVER.1.SG
Cover for Version A1/B1, white	SI-S2.COVER.1.W
Cover for Version A2/B2, black-grey	SI-S2.COVER.2.SG
Cover for Version A2/B2, white	SI-S2.COVER.2.W
Cover for Version E0, black-grey	SI-S2.COVER.E0.SG
Cover for Version E0, white	SI-S2.COVER.E0.W
Cover for Version E1, black-grey	SI-S2.COVER.E1.SG
Cover for Version E1, white	SI-S2.COVER.E1.W
Sleeve nut for escutcheons, pack of 50	S2.SLEEVENUT
S, M, L or X) screw set; indicate length (pack of 10)	S2.SCREW.x
Compensating bushings for version A0/B0, 10 bags with 2 x 3 units in each (in three different lengths)	S2.COMPSHELL
Escutcheon cover without locking cylinder opening, for retrofit	SI-S2.ROSE
Escutcheon cover with locking cylinder opening, for for Euro-profile cylinder retrofit	S2.ROSEPZ
Escutcheon cover without locking cylinder opening, for Scandinavian Oval, for retrofit	SI-S2.ROSESO
Escutcheon cover with locking cylinder opening, for Scandinavian Oval, for retrofit	S2.ROSESO.MO
Extension sleeve from 8 mm to 8.5 mm in length (10 units)	SH.SLEEVES.8.5
Blank cylinder 15–15 mm for Euro Profile cylinder to seal profile cylinder holes in the door	BLANK CYLINDER.PZ
Blank cylinder 15–15 mm for Swiss Round to seal profile cylinder holes in the door	BLANK CYLINDER.SR

DIGITAL
SMART HANDLE AX
SMART INTEGO
FOR GLASS DOORS

// BASIC VERSIONS

Description	Order code
LOCK CASES TO FIT SMARTHANDLE AX ONTO GLASS DOORS	
dormakaba Office Junior lock case for glass doors, designed for SmartHandle AX, DIN left, square shaft 8 mm, for glass doors, with vertically drill holes at a spacing of 80 mm; hole diameter: 50 mm; (SmartHandle must be ordered separately; only version A1 is compatible)	S2.GL08A72L
dormakaba Office Junior lock case for glass doors, prepared for SmartHandle AX, DIN right, Square shaft 8 mm, prepared for glass doors, with vertical holes at a spacing of 80 mm, Hole diameter 50 mm (SmartHandle must be ordered separately; only version A1 is compatible)	S2.GL08A72R
Important notice: The glass door fitting manufacturer is dormakaba. Please contact the manufacturer directly for accessories or further information.	
ACCESSORIES	
Cover for dormakaba Office Junior lock case for glass doors, left, designed for SmartHandle AX	S2.GLCOVERL
Cover for dormakaba Office Junior lock case for glass doors, right, designed for SmartHandle AX	S2.GLCOVERR
ORDER PLACEMENT GUIDE FOR SMART INTEGO COMPONENTS	
You can download an order placement guide for SmartIntego components in the partner section on our website at www.smartintego.com .	



DIGITAL SMART HANDLE SMART INTEGO



Outstanding design. Excellent technology.

Architects, planners and designers agree: the SimonsVoss digital door fitting is amongst the leading solutions both technologically and visually. Its balanced design impresses even the most demanding decision makers around the world.

In the development of the wireless SmartIntego SmartHandle fitting, great emphasis was also placed on exploiting special advantages in buildings with many users. SmartHandle uses a contactless system to communicate with identification media via the card reader integrated into the SmartHandle. It has an average battery life of five years and, like the cylinder, is virtually maintenance-free in online mode for up to 80,000 locking operations for many years.

Another distinctive feature is the innovative snap-in-installation. This simple, instant process can be used on doors up to 100 mm thick without any need to drill additional holes. Awarded the red dot design award, SmartHandle is the obvious choice wherever timeless elegance and a stylish ambience are required due to its range of versions – Euro Profile, Scandinavian Oval and Swiss Round.



DIGITAL SMART HANDLE – SMART INTEGO

COMPOSITION OF THE ITEM NO. WITH EXAMPLE:

Identifier for digital door fitting = SI.SH										
Profile: A = Europrofile/Swiss Round , B = Scandinavian Oval C = Europrofile with MO (Mechanical Override), D = Swiss Round with MO E = Scandinavian Oval with MO, F = Europrofile with rosette fitting* G = Swiss Round with rosette fitting* H = Europrofile with MO - for tubular frame doors, I = Swiss Round with MO - for tubular frame doors										
Profile/door thickness: S = 39 - 60 mm; 33 - 54 mm for SO; 30 - 51 mm for SO with DP; 32 - 50 mm for SKG M = 59 - 80 mm; 53 - 74 mm for SO; 50 - 71 mm for SO with DP; 50 - 70 mm for SKG L = 79 - 100 mm; 73 - 94 mm for SO; 70 - 91 mm for SO with DP; 70 - 90 mm for SKG										
Square shaft: 07 = 7 mm 08 = 8 mm F8 = 8 mm (fire-retardant version) 8,5 mm (via sleeve Hülse SH.SLEEVE.8.5, see accessories) / For SKG-versions only 8 mm (08) available 09 = 9 mm (fire-retardant version) 10 = 10 mm										
Fastening type/plate width: A SnapIn, narrow (41 mm) B SnapIn, wide (53 mm) C Conventional fastening, narrow (41 mm) D Conventional fastening, wide (53 mm) E Conventional fastening with MO – internal and outside recess, narrow (41 mm) F Conventional fastening with MO – internal and outside recess, wide (53 mm) G Conventional fastening with MO – internal blank / outside recess, narrow (41 mm) H Conventional fastening with MO – internal blind / outside recess, wide (53 mm) I Conventional fastening with MO – internal recess / outside blind, narrow (41 mm) J Conventional fastening with MO – internal recess / outside blank, wide (53 mm) K Conventional fastening with MO – internal and outside blind, narrow (41 mm) L = Conventional fastening with MO – internal and outside blank, wide (53 mm)										
Separation: 00 = Conventional fixing 70 = 70 mm 88 = 88 mm 72 = 72 mm 90 = 90 mm 75 = 75 mm 92 = 92 mm 78 = 78 mm 94 = 94 mm (only for Swiss Round) 85 = 85 mm 96 = 96 mm (only for Scandinavian Oval) 05 = 105 mm (for Scandinavian Oval only)										
Version: 0 = engaged (without electronics) 1 = engaged on one side 2 = Door Monitoring with SimonsVoss Sensors 3 = Door Monitoring with external lock sensors 4 = time-controlled return function without additional ohne Door Monitoring functionality										
Handle version, outside: A = L-shaped R (curved round) B = L-shaped G (mitred) C = U-shaped R (curved round) D = U-shaped G (mitred) E = U-shaped R (rounded), offset										
Handle version, inside: A = L-shaped R (curved round) B = L-shaped G (mitred) C = U-shaped R (curved round) D = U-shaped G (mitred) E = U-shaped R (curved round), elbowed K = Knob (only for SKG-version)										
Surface: 1 = Brushed stainless steel 3 = Brass										
Reader technology: 0 = without electronics A = Wireless Online: MIFARE® Classic, MIFARE Plus®, MIFARE® DESFire® / EV1/ EV2, UID (card serial number) as per ISO 14443 (e.g. MIFARE®, Legic® Advant, HID® SEOS), and Calypso Serial number and 7816-4 elementary file 3 = Virtual Card Network: MIFARE® Classic or MIFARE® DESFire® / EV1/ EV2										
Options: WP , E1 (PAS24), DP (only for SO and SKG)										
SI.SH	AS	10	B	85	1	A	A	1	A	WP

Item code for the example given above: SI.SHAS10B851AA1AWP

* Version can also be fitted on the existing fastening holes in conjunction with a mechanical secondary locking device due to its design and installation type

DIGITAL SMART HANDLE – SMART INTEGO

The SimonsVoss SmartHandle digital door fitting for doors combines intelligent access control functions with an elegant, ergonomic design. Its slim, flat exterior, SmartHandle conceals highly innovative technology.

In developing the new SmartHandle door fitting, we particularly focussed on the demands of use in outdoor areas. The digital SmartHandle can be used on doors fitted with Euro Profile cylinders, Swiss Round and Scandinavian Oval mortise locks.

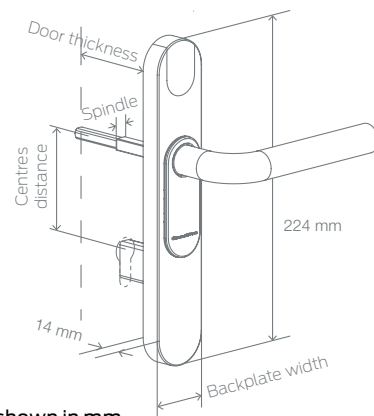

Measurements shown in mm

// UNIQUE SELLING POINT

The innovative snap-in fitting system means that there is no need to drill holes in doors. This means existing doors are not damaged and installation times are greatly reduced.

Cable-free on-line door monitoring: Sensitive rooms can be equipped with DoorMonitoring if required. The cable-free on-line door monitoring system records, logs and reports all door statuses using sensor control to detect whether doors are open, closed, or locked.

// TYPES OF FIXING

see next pages

// TECHNICAL DATA

- ∴ Types: Euro Profile cylinder (as per DIN 18252 / EN1303), Swiss Round, Scandinavian Oval
- ∴ Dimensions (W x H x D):
Narrow: 41 x 224 x 14 mm
Wide: 53 x 224 x 14 mm
- ∴ Dimensions (W x H x D):
Narrow: 48 x 230.2 x 21.75 mm
Wide: 59 x 229.2 x 21.75 mm
- ∴ Read procedure Wireless Online:
MIFARE® Classic, MIFARE Plus®, MIFARE® DESFire® / EV1/EV2, UID (card serial number) as per ISO 14443 (e.g. MIFARE®, Legic® Advant, HID® SEOS), and Calypso Serial number and 7816-4 elementary file
- ∴ Read procedure Virtual Card Network:
MIFARE® Classic or MIFARE® DESFire® / EV1/EV2
- ∴ Battery type: 2 x lithium CR2450 3V Lithium
- ∴ Battery lifetime;
Wireless Online: up to 80,000 activations
Virtual Card Network: up to 50,000 activations
Wireless Online stand-by: up to 5 years
Virtual Card Network stand-by: up to 5 years
- ∴ Temperature range: operation –20 °C to +50 °C
- ∴ Storage (short term): –40°C to +70°C
Storage (long term): 0°C to +30°C
- ∴ Feedback signal: audible (buzzer) and visual (LED: blue/red)

DIGITAL SMART HANDLE – SMART INTEGO



// WIRELESS ONLINE (868 MHZ)

- :: Reads 5 different card set-ups
- :: Opened after release by access control system (short release interval) with variable time settings
- :: Permanent release (on/off) with timer function
- :: Office mode with timer function
- :: DoorMonitoring function with SimonsVoss sensors
- :: DoorMonitoring function with external locking device sensor (locking device not included in the delivery package)
- :: Time-controlled return function
- :: Construction White List function with up to 128 cards
- :: White List function with up to 250 offline cards
- :: Recording of accesses even in the event of network failure
- :: Transmission of battery status and QoS (quality of signal)
- :: Configurable "keep alive" event
- :: 'Integrator lock'
- :: Auto-configuration via SmartIntego Manager (in TCP/IP Gateway Node models only)

// VIRTUAL CARD NETWORK

- :: Issue of authorisations (access) based on doors areas, groups and exception functions
- :: Battery status
- :: Blacklist transfer, including feedback signal
- :: Physical access lists
- :: Time budget / activation and expiration date
- :: Data deletion on online terminal
- :: Initial programming possible using access control manufacturer's online reader
- :: Time profiles on the card
- :: Data transmission secured during writing and read procedure
- :: Time-controlled return function

// TYPES OF FIXING

There are four different types of fixing with digital SmartHandle: SnapIn, conventional fixing, rosette fitting and conventional fitting with mechanical override (MO).



// BASIC VERSIONS

Description	WIRELESS ONLINE Order code	VIRTUAL CARD NETWORK Order code
DIGITAL SMART HANDLE – SMART INTEGO		
Digital SmartHandle – SmartIntego – Snap-in		
Electronic door handle for mounting on doors, with handle lock designed for Euro Profile and Swiss Round. Outer side can be operated with MIFARE® SmartCards/SmartTags only; inner side is permanently engaged.	SI.SHA*...A**...A*** SI.SHA*...B**...A***	SI.SHA*..A**...3** SI.SHA*..B**...3**
Digital SmartHandle – SmartIntego – Conventional Fastening		
Electronic door handle for conventional mounting with screws, with handle lock designed for Euro Profile and Swiss Round. Outer side can be operated with SmartCards/SmartTags only; inner side is permanently engaged.	SI.SHA*...C**...A*** SI.SHA*...D**...A***	SI.SHA*...C**.....3*** SI.SHA*...D**...3***

DIGITAL
SMART HANDLE –
SMART INTEGO

// BASIC VERSIONS

Description	WIRELESS ONLINE Order code	VIRTUAL CARD NETWORK Order code
DIGITAL SMART HANDLE – SMART INTEGO		
<p>Digital SmartHandle – SmartIntego – Conventional fastening with MO for Euro Profile</p> <p>Digital door handle for conventional fitting with screws, with handle lock designed for Euro Profile. Outer side can only be operated with SmartCards/ SmartTags; inner side is permanently engaged.</p>	SI.SHC*...E-L**...A***	SI.SHC*...E-L**...3***
<p>Digital SmartHandle – SmartIntego – Conventional fastening with MO for Swiss Round</p> <p>Digital door handle for conventional fitting with screws, with handle lock designed for Swiss Round. Outer side can only be operated with SmartCards/ SmartTags; inner side is permanently engaged.</p>	SI.SHD*...E-L**...A***	SI.SHD*...E-L**...3***
<p>Digital SmartHandle SmartIntego– Fastening for installation on rosettes with MO– for Euro Profile</p> <p>Digital door handle for conventional installation with screws; additional options for installing a mechanical cylinder as a secondary lock; equipped with a handle lock for Euro Profile; outside can be operated with MIFARE® SmartCards/ SmartTags; inside is permanently engaged</p>	SI.SHF*...E-L**...A***	SI.SHF*...E-L**...3***
<p>Digital SmartHandle SmartIntego– Fixing for installation on rosettes with MO– for Swiss Round</p> <p>Digital door handle for conventional installation with screws; additional options for installing a mechanical cylinder as a secondary lock; equipped with a handle lock for Swiss Round; outside can only be operated with MIFARE® SmartCards/ SmartTags; inside is permanently engaged</p>	SI.SHG*...E-L**...A***	SI.SHG*...E-L**...3***
<p>Digital SmartHandle SmartIntego– Fixing for mounting to metal frame doors with MO – for Euro Profile</p> <p>Digital door fitting for conventional mounting on doors with screws; additional options for installing a mechanical cylinder as a secondary lock; equipped with a handle lock for Euro Profile; outside can be operated with SmartCards/ SmartTags, inside is always engaged.</p>	SI.SHH*...E-L**...A***	SI.SHH*...E-L**...3***
<p>Digital SmartHandle SmartIntego– Fixing for mounting to metal frame doors with MO – for Swiss Round</p> <p>Digital door handle for conventional mounting on doors with screws; additional options for installing a mechanical cylinder as a secondary lock; equipped with a handle lock for Swiss Round; outside can be operated with SmartCards/ SmartTags, inside is always engaged.</p>	SI.SHI*...E-L**...A***	SI.SHI*...E-L**...3***

For detailed information on the composition of article No. see p.38

* Identification number for profile: e.g. A=Europrofile/Swiss Round

** Identification number for fixing/plate width: e.g C=conventional fixing narrow

*** Identification number for reading technology/option: e.g A=Wireless online, WP=weatherproof version

DIGITAL
SMART HANDLE –
SMART INTEGO

// OPTIONS

Description	WIRELESS ONLINE Order code	VIRTUAL CARD NETWORK Order code
PROFILE		
Euro Profile / Swiss Round	A	A
Euro Profile with mechanical override (MO)	C	C
Swiss Round with mechanical override (MO)	D	D
Euro Profile with MO – rosette installation	F	F
Swiss Round with MO – rosette installation	G	G
Euro Profile with MO – for tubular frame doors	H	H
Swiss Round with MO – for tubular frame doors	I	I
DOOR THICKNESS		
39 – 60 mm	S	S
59 – 80 mm	M	M
79 – 100 mm	L	L
SPINDLE		
7 mm	07	07
8 mm	08	08
8 mm (fire-retardant version)	F8	F8
9 mm (fire-retardant version)	09	09
10 mm	10	10
FIXING/PLATE WIDTH		
Snap-in plate (41 mm)	A	A
Snap-in plate (53mm)	B	B
Conventional fastening, narrow (41 mm)	C	C
Conventional fastening, wide (53 mm)	D	D
Conventional fastening with MO – internal and outside recess, narrow (41 mm)	E	E
Conventional fastening with MO – internal and outside recess, wide (53 mm)	F	F
Conventional fastening with MO – internal blind / outside recess, narrow (41 mm)	G	G

DIGITAL
SMART HANDLE –
SMART INTEGO

// OPTIONS

Description	WIRELESS ONLINE Order code	VIRTUAL CARD NETWORK Order code
Conventional fastening with MO – internal blind / outside recess, wide (53 mm)	H	H
Conventional fixing with MO – internal recess / outside blind, narrow (41 mm)	I	I
Conventional fixing with MO – internal recess / outside blind, wide (53 mm)	J	J
Conventional fixing with MO – internal and outside blind, narrow (41 mm)	K	K
Conventional fixing with MO – internal and outside blind, wide (53 mm)	L	L
CENTRES DISTANCE*		
Conventional fixing	00	00
70 mm (for snap-in only)	70	70
72 mm (for Snap-in and Mechanical Override only)	72	72
74 mm (for Snap-in and Mechanical Override only)	74	74
75 mm (for Snap-in and Mechanical Override only)	75	75
78 mm (for Snap-in and Mechanical Override only)	78	78
85 mm (for Snap-in and Mechanical Override only)	85	85
88 mm (for Snap-in and Mechanical Override only)	88	88
92 mm (for Snap-in and Mechanical Override only)	92	92
94 mm (for Swiss Round only and for Snap-in and Mechanical Override only)	94	94
VERSION		
Engaged (for SmartHandle without electronics only)	0	0
Engages for use on one side (for all SmartHandles with electronics)	1	1
Engaged one side, DoorMonitoring-functionality with SimonsVoss sensors	2	
Engaged one side, DoorMonitoring with connection to sensor locks	3	
DoorMonitoring with time-controlled return function With no other DoorMonitoring functionality	4	4
EXTERIOR HANDLE VERSION		
L-shaped R (rounded)	A	A
L-shaped G (mitred)	B	B
U-shaped R (rounded)	C	C

* The centres distance is always 00 with fixing system C, D, K, L

DIGITAL
SMART HANDLE –
SMART INTEGO

// OPTIONS

Description	WIRELESS ONLINE Order code	VIRTUAL CARD NETWORK Order code
U-shaped G (mitred)	D	D
U-shaped R (rounded), offset	E	E
HANDLE VERSION, INSIDE		
L-shaped R (rounded)	A	A
L-shaped G (mitred)	B	B
U-shaped R (rounded)	C	C
U-shaped G (mitred)	D	D
U-shaped R (rounded), offset	E	E
SURFACE		
Stainless steel, brushed	1	1
Brass design (on request)	3	3
READER TECHNOLOGY		
Wireless Online: MIFARE® Classic, MIFARE Plus®, MIFARE® DESFire® / EV1/EV2, UID (card serial number) as per ISO 14443 (e.g. MIFARE®, Legic® Advant, HID® SEOS), and Calypso Serial number and 7816-4 elementary file	A	–
Virtual Card Network: MIFARE® Classic or MIFARE® DESFire® / EV1/EV2	–	3
OPTIONS		
Weatherproof version (outer side of SmartHandle only)	WP	WP
Version with security classification ES1 and PAS24	E1	E1
Drilling Protection (only for SO and SKG)	DP	DP
SPINDLE		
Sleeve from 8 mm to 8.5 mm (10 units)	SH.SLEEVES.8.5	SH.SLEEVES.8.5
Sleeve from 7 to 8 mm (10 units)	SH.SLEEVES.7.8	SH.SLEEVES.7.8

COVER FOR POST-FITTING (EURO/SWISS)

// COVER

Description	WIRELESS ONLINE Order code	VIRTUAL CARD NETWORK Order code
Inside cover (narrow) and inlay for retrofit or as replacement	SI.SH.CS	SI.SH.CS
Inside cover (narrow, Euro Profile) and inlay for retrofit or as replacement; indicate the centres distance for recess (e.g. 72 mm)	SI.SH.CS.xx	SI.SH.CS.xx
Outer cover (narrow) and inlay for retrofit or as a replacement	SI.SH.2.CSP	SI.SH.2.CSP
Outside cover (narrow, Euro Profile) and inlay for retrofit or as a replacement; indicate the centres distance for the cut-out (e.g. 72 mm)	SI.SH.2.CSP.XX	SI.SH.2.CSP.XX
Inside cover (wide) and inlay for retrofit or as replacement	SI.SH.CB	SI.SH.CB
Inside cover (wide, Euro Profile) and inlay for retrofit or as replacement; indicate the centres distance for recess (e.g. 72 mm)	SI.SH.CB.XX	SI.SH.CB.XX
Outer cover (wide) and inlay for retrofit or as a replacement	SI.SH.2.CBP	SI.SH.2.CBP
Outside cover (wide, Euro Profile) and inlay for retrofit or as replacement; indicate the centres distance for recess (e.g. 72 mm)	SI.SH.2.CBP.XX	SI.SH.2.CBP.XX
Inside cover (narrow, Swiss Round) and inlay for retrofit or as replacement; indicate the centres distance for recess (e.g. 78 mm)	SI.SH.CS.SR.I.XX	SI.SH.CS.SR.I.XX
Inside cover (wide, Swiss Round) and inlay for retrofit or as replacement; indicate the centres distance for recess (e.g. 78 mm)	SI.SH.CB.SR.I.XX	SI.SH.CB.SR.I.XX
Outer cover (narrow, Swiss Round) and inlay for retrofit or as replacement; indicate the centres distance for recess (e.g. 78 mm)	SI.SH.2.CSP.SR.A.XX	SI.SH.2.CSP.SR.A.XX
Outer cover (wide, Swiss Round) and inlay for retrofit or as replacement; indicate the centres distance for recess (e.g. 78 mm)	SI.SH.2.CBP.SR.A.XX	SI.SH.2.CBP.SR.A.XX

HANDLES FOR RETRO-FITTING

// HANDLE

Description	WIRELESS ONLINE Order code	VIRTUAL CARD NETWORK Order code
SmartHandle lever handle for retrofitting or conversion – L-shape round curved Inside and outside handle – with locking ring and socket screw	SH.LEVA	SH.LEVA
SmartHandle lever handle for retrofitting or conversion – L-shaped with mitre Inside and outside handle – with locking ring and socket screw	SH.LEVB	SH.LEVB
SmartHandle lever handle for retrofitting or conversion – U-shape round curved Inside and outside handle – with locking ring and socket screw	SH.LEVC	SH.LEVC
SmartHandle lever handle for retrofitting or conversion – U-shaped with mitre Inside and outside handle – with locking ring and socket screw	SH.LEVD	SH.LEVD
SmartHandle lever handle for retrofitting or conversion – U-shape round curved elbowed- for metal frame doors – Inside and outside handle – with locking ring and socket screw	SH.LEVE	SH.LEVE
SmartHandle handle for retrofitting or conversion – only for SH with interchangeable lever handles on both sides – U-shape round curved – Inside and outside lever handles with locking ring and Allen screw with antibacterial coating	SH.LEVC.AB	SH.LEVC.AB
Lock ring for interchangeable handle for SmartHandle; contains 10 items:	SH.RING	SH.RING



DIGITAL SMART HANDLE – SKG – SMART INTEGO

// BASIC VERSIONS

Description	WIRELESS ONLINE Order code	VIRTUAL CARD NETWORK Order code
DIGITAL SMART HANDLE – SKG – Smart Intego		
Electronic door fitting – SKG – conventional fixing:		
Electronic door handle for conventional mounting with screws, SKG approval SKG**, with handle lock designed for Euro Profile; outer side can be operated with SmartCards/SmartTags; internal is always engaged	SI.SHA*..C**...ADP*** SI.SHA*..D**...ADP***	SI.SHA*..C**...3DP*** SI.SHA*..D**...3DP***

DIGITAL SMART HANDLE – SKG – SMART INTEGO

// OPTIONS

Description	WIRELESS ONLINE Order code	VIRTUAL CARD NETWORK Order code
PROFILE		
Euro Profile	A	A
DOOR THICKNESS		
32 – 50 mm	S	S
50 – 70 mm	M	M
70 – 90 mm	L	L
SPINDLE		
8 mm	08	08
FIXING/PLATE WIDTH		
Conventional fastening, narrow (47 mm)	C	C
Conventional fastening, wide (59 mm)	D	D
CENTRES DISTANCE		
Conventional fixing for versions C, D, K, L	00	00
VERSION		
Engages for use on one side (for all SmartHandles with electronics)	1	1
Engaged one side, DoorMonitoring-functionality with SimonsVoss sensors	2	–
Engaged one side, DoorMonitoring with connection to sensor locks	3	–
DoorMonitoring with time-controlled return function With no other DoorMonitoring functionality	4	4

DIGITAL SMART HANDLE – SKG – SMART INTEGO

// OPTIONS

Description	WIRELESS ONLINE Order code	VIRTUAL CARD NETWORK Order code
EXTERIOR HANDLE VERSION		
L-shaped R (rounded)	A	A
L-shaped G (mitred)	B	B
U-shaped R (rounded)	C	C
U-shaped G (mitred)	D	D
U-shaped R (rounded), offset	E	E
HANDLE VERSION INSIDE		
Inside thumb-turn	K	K
SURFACE FINISH		
Stainless steel, brushed	1	1
READER TECHNOLOGY		
Wireless Online: MIFARE® Classic, MIFARE Plus®, MIFARE® DESFire® / EV1/EV2, UID (card serial number) as per ISO 14443 (e.g. MIFARE®, Legic® Advant, HID® SEOS), and Calypso Serial number and 7816-4 elementary file	A	–
Virtual CardNetwork: MIFARE® Classic or MIFARE® DESFire® / EV1/EV2	–	3
OPTIONS		
Weatherproof version (applies to outer side only)	WP	WP
Drilling Protection	DP	DP

DIGITAL SMART HANDLE – SCANDINAVIAN OVAL – SMART INTEGO



// BASIC VERSIONS

Description	WIRELESS ONLINE Order code	VIRTUAL CARD NETWORK Order code
DIGITAL SMART HANDLE – SCANDINAVIAN OVAL – SI		
Digital SmartHandle – Scandinavian Oval – SI Digital door handle for fitting on doors, with handle lock designed for Scandinavian Oval. Outside can be operated with SmartCards/SmartTags; inner side is permanently engaged.	SI.SHB*.....A***	SI.SHB*.....3***
Digital SmartHandle – Scandinavian Oval – SI with MO Digital door handle for mounting on doors; additional options for installing a mechanical cylinder as a secondary lock; with handle lock designed for Scandinavian Oval; outside can be operated with SmartCards/SmartTags; inside is permanently engaged ready for use	SI.SHE*.....A***	SI.SHE*.....3***

// OPTIONS

Description	WIRELESS ONLINE Order code	VIRTUAL CARD NETWORK Order code
PROFILE		
Scandinavian Oval	B	B
Scandinavian Oval with Mechanical Override (MO)	E	E
DOOR THICKNESS		
33 – 54 mm 30 – 51 mm for versions with drilling protection	S	S
53 – 74 mm 50 – 71 mm for versions with drilling protection	M	M
73 – 94 mm 70 – 91 mm for versions with drilling protection	L	L
SPINDLE		
7 mm	07	07
8 mm	08	08
8 mm (fire-retardant version)	F8	F8
9 mm (fire-retardant version)	09	09
10 mm	10	10

For detailed information on the composition of article No. see p.38

* Identification number for profile: e.g. A=Europrofile/Swiss Round

** Identification number for fixing/plate width: e.g. C=conventional fixing narrow

*** Identification number for reading technology/option: e.g. A=Wireless online, WP=weatherproof version

DIGITAL
SMART HANDLE –
SCANDINAVIAN OVAL –
SMART INTEGO

// OPTIONS

Description	WIRELESS ONLINE Order code	VIRTUAL CARD NETWORK Order code
FIXING/PLATE WIDTH		
Conventional fixing narrow (41 mm: plate width 41 mm / Adapter plate width 48 mm)	C	C
Conventional fixing wide (53 mm: plate width 53mm / Adapter plate width 59 mm)	D	D
Conventional fastening with MO – internal and outside recess, narrow (41 mm)	E	E
Conventional fastening with MO – internal and outside recess, wide (53 mm)	F	F
Conventional fastening with MO – internal blind / outside recess, narrow (41 mm)	G	G
Conventional fastening with MO – internal blind / outside recess, wide (53 mm)	H	H
Conventional fixing with MO – internal recess / outside blind, narrow (41 mm)	I	I
Conventional fixing with MO – internal recess / outside blind, wide (53 mm)	J	J
Conventional fixing with MO – internal and outside blind, narrow (41 mm)	K	K
Conventional fixing with MO – internal and outside blind, wide (53 mm)	L	L
CENTRES DISTANCE		
Extra charge for conventional fixing versions C, D, K, L	00	00
96 mm	96	96
105 mm	05	05

DIGITAL
SMART HANDLE –
SCANDINAVIAN OVAL –
SMART INTEGO

// OPTIONS

Description	WIRELESS ONLINE Order code	VIRTUAL CARD NETWORK Order code
VERSION		
Engaged (for SmartHandle without electronics only)	0	0
Engages for use on one side	1	1
Engaged f one side, DoorMonitoring with connection to sensor locks	3	–
DoorMonitoring with time-controlled return function With no other DoorMonitoring functionality	4	4
EXTERIOR HANDLE VERSION		
L-shaped R (rounded)	A	A
L-shaped G (mitred)	B	B
U-shaped R (rounded)	C	C
U-shaped G (mitred)	D	D
U-shaped R (rounded), offset	E	E
HANDLE VERSION, INSIDE		
L-shaped R (rounded)	A	A
L-shaped G (mitred)	B	B
U-shaped R (rounded)	C	C
U-shaped G (mitred)	D	D
U-shaped R (rounded), offset	E	E
SURFACE		
Stainless steel, brushed	1	1
Brass design (on request)	3	3

DIGITAL
SMART HANDLE –
SCANDINAVIAN OVAL –
SMART INTEGO

// OPTIONS

Description	WIRELESS ONLINE Order code	VIRTUAL CARD NETWORK Order code
READER TECHNOLOGY		
Wireless Online: MIFARE® Classic, MIFARE Plus®, MIFARE® DESFire® / EV1/EV2, UID (card serial number) as per ISO 14443 (e.g. MIFARE®, Legic® Advant, HID® SEOS), and Calypso Serial number and 7816-4 elementary file	A	–
Virtual CardNetwork: MIFARE® Classic or MIFARE® DESFire® / EV1/EV2	–	3
OPTIONS		
Weatherproof version (outer side of SmartHandle only)	WP	WP
Drilling Protection	DP	DP

COVER FOR RETRO-FITTING (SCANDINAVIAN OVAL)

// COVER

Description	WIRELESS ONLINE Order code	VIRTUAL CARD NETWORK Order code
Inside cover (narrow, Scandinavian Oval) and inlay for retrofit or as a replacement	SI.SH.CS.SO	SI.SH.CS.SO
Inside cover (narrow, Scandinavian Oval) and inlay for retrofit or as a replacement; indicate the centres distance for the recess (e.g. 105 mm)	SI.SH.CS.SO.xx	SI.SH.CS.SO.xx
Inside cover (wide, Scandinavian Oval) and inlay for retrofit or as a replacement	SI.SH.CB.SO	SI.SH.CB.SO
Inside cover (wide, Scandinavian Oval) and inlay for retrofit or as a replacement; indicate the centres distance for the recess (e.g. 105 mm)	SI.SH.CB.SO.xx	SI.SH.CB.SO.xx
Outside cover (narrow, Scandinavian Oval) for SmartIntego fittings and inlay for retrofit or as a replacement	SI.SH.CSP.SO	SI.SH.CSP.SO
Outer cover (narrow, Scandinavian Oval) for SmartIntego fittings and inlay for retrofit or as a replacement, specify centres distance for cut-out (e.g. 105 mm)	SI.SH.CSP.SO.xx	SI.SH.CSP.SO.xx
Outer cover (wide, Scandinavian Oval) for SmartIntego fittings and inlay for retrofit or as a replacement	SI.SH.CBP.SO	SI.SH.CBP.SO
Outer cover (wide, Scandinavian Oval) for SmartIntego fittings and inlay for retrofit or as a replacement specify centres distance for cut-out (e.g. 105 mm)	SI.SH.CBP.SO.xx	SI.SH.CBP.SO.xx
Outside cover (narrow, Scandinavian Oval) for SmartIntego SmartCard-fittings(RO) and Inlay for retro-fitting or replacement	SI.SH.2.CSP.SO	SI.SH.2.CSP.SO
Outside cover (narrow, Scandinavian Oval) for SmartIntego SmartCard fittings (RO) and inlay for retrofit or as replacement; indicate the centres distance for the recess (e.g. 105 mm)	SI.SH.2.CSP.SO.xx	SI.SH.2.CSP.SO.xx
Outside cover (wide, Scandinavian Oval) for SmartIntego SmartCard-fittings(RO) and Inlay for retro-fitting or replacement	SI.SH.2.CBP.SO	SI.SH.2.CBP.SO
Outside cover (wide, Scandinavian Oval) for SmartIntego SmartCard fittings (RO) and inlay for retrofit or as replacement; indicate the centres distance for the recess (e.g. 105 mm)	SI.SH.2.CBP.SO.xx	SI.SH.2.CBP.SO.xx

HANDLES FOR RETRO-FITTING

// HANDLE

Description	WIRELESS ONLINE Order code	VIRTUAL CARD NETWORK Order code
SmartHandle lever handle for retrofitting or conversion – L-shape round curved Inside and outside handle – with locking ring and socket screw	SH.LEVA	SH.LEVA
SmartHandle lever handle for retrofitting or conversion – L-shaped with mitre Inside and outside handle – with locking ring and socket screw	SH.LEVB	SH.LEVB
SmartHandle lever handle for retrofitting or conversion – U-shape round curved Inside and outside handle – with locking ring and socket screw	SH.LEVC	SH.LEVC
SmartHandle lever handle for retrofitting or conversion – U-shaped with mitre Inside and outside handle – with locking ring and socket screw	SH.LEVD	SH.LEVD
SmartHandle lever handle for retrofitting or conversion – U-shape round curved elbowed- for metal frame doors – Inside and outside handle – with locking ring and socket screw	SH.LEVE	SH.LEVE
SmartHandle handle for retrofitting or conversion – only for SH with interchangeable lever handles on both sides – U-shape round curved – Inside and outside lever handles with locking ring and Allen screw – with antibacterial coating	SH.LEVC.AB	SH.LEVC.AB
Lock ring for interchangeable handle for SmartHandle; contains 10 items:	SH.RING	SH.RING





DIGITAL PIN CODE TERMINAL SMART INTEGO

DIGITAL PIN CODE-TERMINAL SMART INTEGO



Made of silver-coloured ABS plastic, the ultra-slim PIN code terminal can be mounted indoors or outdoors with no wiring necessary. It can be surface-mounted, also onto glass when required. Batteries last for up to 50,000 activations or up to five years on stand-by for Wireless Online. Awarded the IF Product Design Award, the exceptional SmartIntego Digital PIN code terminal functions reliably within a temperature range between $-25\text{ }^{\circ}\text{C}$ and $+65\text{ }^{\circ}\text{C}$.

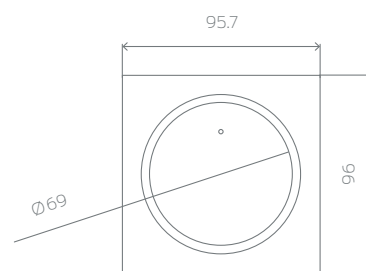

Measurements shown in mm

// TECHNICAL DATA

- :: Silver-coloured ABS plastic housing
- :: Dimensions: 96 x 95.7 x 14 mm (H x W x D)
- :: Weight: about 120 g including batteries
- :: Standard protection rating IP66,
- :: Battery type: 4 x CR2032 3 V Lithium
- :: Battery life: up to 50,000 activations or up to five years on stand-by with Wireless Online
- :: 2-level battery warning system
- :: Temperature range: $-25\text{ }^{\circ}\text{C}$ to $+65\text{ }^{\circ}\text{C}$
- :: Cable-free surface mount

// WIRELESS ONLINE (868 MHz)

- :: PIN length determined in the PIN code terminal (number length: 1–9)
- :: Flexible management and handling within the AC system (PIN, chip & PIN and similar)
- :: Use in conjunction with SmartHandles, locking cylinders and padlocks
- :: Use in conjunction with AC components (e.g. light control, alarm and similar)

// PRODUCT VERSIONS

PIN code Terminal – SmartIntego:

Battery-powered, wireless PIN code terminal with 868 MHz wireless interface as identification medium, silver-coloured, ABS plastic housing, protection rating IP65

SI.PINCODE

5 batteries for PIN code terminal (type: CR2032)

TRA.BAT



DIGITAL PADLOCKS SMART INTEGO

DIGITAL PADLOCK SMART INTEGO



// TECHNICAL DATA

- ∴ Version 8 mm shackle diameter
Dimensions:
(W x H x D) without cylinder knob 51 x 70 x 25 mm
- ∴ Version 11 mm shackle diameter
Dimensions:
(W x H x D) without cylinder knob 60 x 72.5 x 25 mm
- ∴ Shackle diameter: 8 / 11 mm
- ∴ Versions:
ML: Not self-locking
SL: Self-locking
- ∴ Shackle height: 25 mm, 50 mm, 60 mm
- ∴ Standard protection rating IP 66,
- ∴ Battery type: 2 x lithium CR2450 3V Lithium
- ∴ Battery lifetime:
Wireless Online: up to 80,000 closures
Virtual Card Network: up to 50,000 closures
Wireless Online Stand-by: up to 5 years
Virtual Card Network Stand-by: up to 5 years
- ∴ Temperature range:
operation -25 °C to +65 °C

// WIRELESS ONLINE (868 MHZ)

- ∴ Reads 5 different card set-ups
- ∴ Opened after release by access control system (short release interval) with variable time settings
- ∴ Permanent release (on/off) with timer function
- ∴ Office mode with timer function
- ∴ White List function with up to 250 offline cards
- ∴ Recording of accesses even in the event of network failure
- ∴ Transmission of battery status and QoS (quality of signal)
- ∴ Configurable "keep alive" event
- ∴ Construction White List function with up to 128 cards
- ∴ 'Integrator lock'
- ∴ Auto-configuration via SmartIntego Manager (in TCP/IP Gateway Node models only)

// VIRTUAL CARD NETWORK

- ∴ Issue of authorisations (access) based on doors, areas, groups and exception functions
- ∴ Battery status
- ∴ Office mode with "timer" function
- ∴ Physical access lists
- ∴ Time budget / activation and expiration date
- ∴ Data deletion on online terminal
- ∴ Initial programming possible using access control manufacturer's online reader
- ∴ Time profiles on the card
- ∴ Data transmission secured during writing and read procedure

DIGITAL
PADLOCK
SMART INTEGO

// BASIC VERSIONS

Description	WIRELESS ONLINE Order code	VIRTUAL CARD NETWORK Order code
<p>Digital Padlock SmartIntego with a shackle diameter of 8 mm and shackle internal height of 25 mm, internal power supply; locking device operated from outside with SmartCards/SmartTags; no wiring required; padlock dimensions: (W x H x D) without cylinder knob 51 x 70 x 25 mm</p> <p>Manual locking:</p> <p>Self-locking</p>	<p>SI.Z4.PL.08.25.MI.ML.WP</p> <p>SI.Z4.PL.08.25.MI.SL.WP</p>	<p>SI.Z4.PL.08.25.M.ML.WP</p> <p>SI.Z4.PL.08.25.M.SL.WP</p>
<p>Digital Padlock SmartIntego with a shackle diameter of 8 mm and shackle internal height of 60 mm, internal power supply; locking device operated from outside with SmartCards/SmartTags; no wiring required; padlock dimensions: (W x H x D) without cylinder knob 60 x 72.5 x 25 mm</p> <p>Manual locking:</p> <p>Self-locking</p>	<p>SI.Z4.PL.08.60.MI.ML.WP</p> <p>SI.Z4.PL.08.60.MI.SL.WP</p>	<p>SI.Z4.PL.08.60.M.ML.WP</p> <p>SI.Z4.PL.08.60.M.SL.WP</p>
<p>Digital Padlock SmartIntego with a shackle diameter of 11 mm and shackle internal height of 35 mm, internal power supply; locking device operated from outside with SmartCards/SmartTags; no wiring required; padlock dimensions: (W x H x D) without cylinder knob 60 x 72.5 x 25 mm</p> <p>Manual locking:</p>	<p>SI.Z4.PL.11.35.MI.ML.WP</p>	<p>SI.Z4.PL.11.35.M.ML.WP</p>
<p>Digital Padlock SmartIntego with a shackle diameter of 11 mm and shackle internal height of 50 mm, internal power supply; locking device operated from outside with SmartCards/SmartTags; no wiring required; padlock dimensions: (W x H x D) without cylinder knob 60 x 72.5 x 25 mm</p> <p>Self-locking</p>	<p>SI.Z4.PL.11.50.MI.SL.WP</p>	<p>SI.Z4.PL.11.50.M.SL.WP</p>
ACCESSORIES		
<p>Securing chain for padlock, shackle 11 mm in diameter, Length: about 30 cm</p>	<p>PL.CHAIN.11.30</p>	<p>PL.CHAIN.11.30</p>
<p>Securing chain for padlock, shackle 8 mm in diameter, Length: about 30 cm</p>	<p>PL.CHAIN.08.30</p>	<p>PL.CHAIN.08.30</p>
<p>Wall bracket for securing chain</p>	<p>PL.CHAIN.BRACKET</p>	<p>PL.CHAIN.BRACKET</p>



PROGRAMMING SMART INTEGO

PROGRAMMING DEVICE SMART INTEGO SMART CD

Programming Device SmartIntego SmartCD



The SI.SMARTCD is used as a programming device for SmartIntego. The SI.SMARTCD is connected to the configuration software (SI.SW) via a USB port.
(No authorisation cards/IDs are programmed for users)

The following items may be programmed.

- ❖ Creation of a battery replacement card This card can be used to reset a battery warning on the locking device concerned. The batteries need to be replaced before the reset.
- ❖ Creation of a testing card to check the wireless connection between a locking device and a GatewayNode. An optical/audible feedback signal on the locking device indicates connection is established. The locking device is not opened during the test.
- ❖ Construction site locking system: each card issued is authorised for all locking devices
- ❖ Change to configuration on the locking device
- ❖ Offline white list read from locking device

// TECHNICAL DATA

- ❖ Housing made of dark-grey polyamide
- ❖ Dimensions: 112 x 63 x 22 mm (H x W x D)
- ❖ Standard protection rating IP 20
- ❖ Power supply via USB port
- ❖ Temperature range: -5 °C to +60 °C



NETWORK STRUCTURE SMART INTEGO

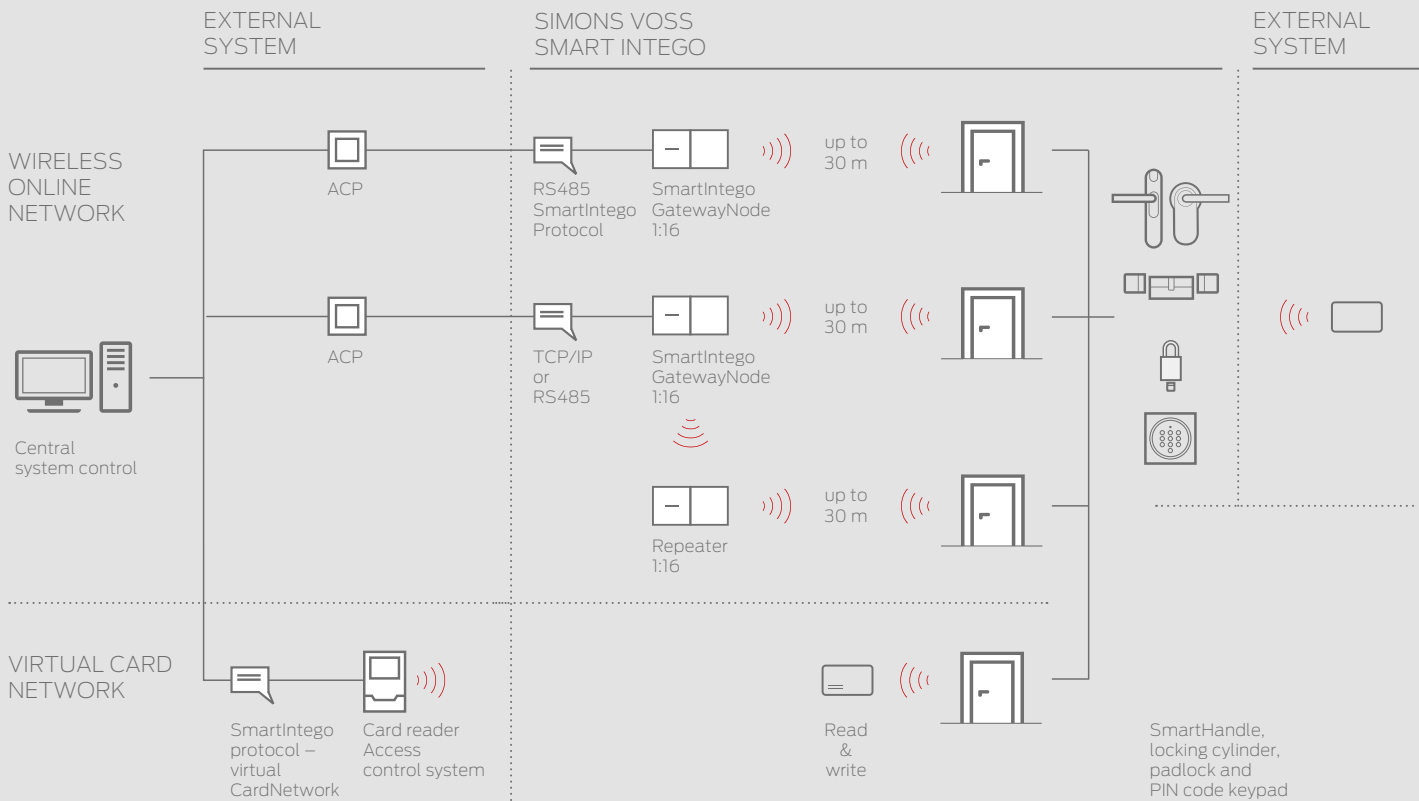

GATEWAY NODE – SMART INTEGO



The SmartIntego Gateway Node can be easily integrated into existing building network structures using TCP/IP or RS485. A connection can thus be established between the access control system (software) and the GatewayNode via standardised interfaces. Data transfer is thus assured from the node to the locking devices via the 868 MHz wireless interface. All necessary network settings are configured in the SmartIntego Manager in the SmartIntego software (SI.SW).

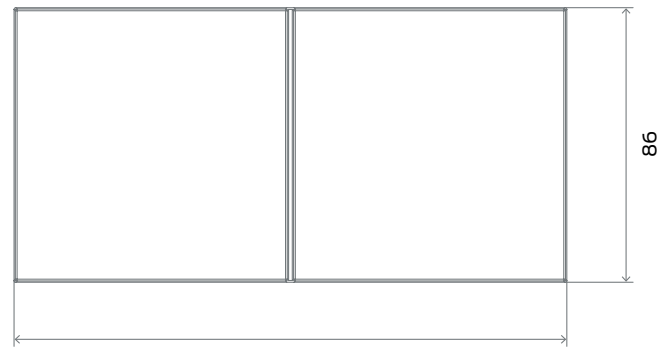

172
Measurements shown in mm

// ASSEMBLIES FOR WIRELESS ONLINE

SmartIntego configuration software (SI.SW):

- ⚡ Software to configure all necessary settings (e.g. card technology etc) for operation in an access control system.
- ⚡ After configuration, SmartIntego makes the necessary network settings (IPsettings, network topology/network addressing) and then the locking devices are programmed for initial operation.
- ⚡ A configuration file from SI.SW is then transferred to the access control system for continued operation.

GatewayNode:

- ⚡ Connection via TCP/IP (SI.GN2.ER or SI.GN2.ER.M) or RS485 (SI.GN.CR) connection to access control system to relay data to the locking devices via the wireless interface (868 MHz).
- ⚡ Up to 16 locking devices can be assigned to one GatewayNode.
- ⚡ The radio range between GatewayNode and locking device is up to 30 m within the building (depending on the building structure).
- ⚡ It is possible to increase the radio range with SI.GN.R (similar to a repeater function).
- ⚡ The quality of radio signals between the GatewayNode and the locking device can be determined using two testing devices (SI.GN.TESTER.BAMO.EU) ("illuminate").

// TECHNICAL SPECIFICATIONS FOR THE GATEWAY NODE:

- ⚡ ABS-plastic housing, UV stable,
Colour: 9/118645 like RAL 9016 (traffic white)
- ⚡ Dimensions: 172 x 86 x 33 mm (L x W x H)
- ⚡ External power supply:
regulated power supply 9 – 32V DC, jack plug
- ⚡ Output: max. 3 VA
- ⚡ Transmission power of the radio module:
10 dBm (c. 10 mW) at the antenna socket
- ⚡ Radio frequency: 868.xx – 870 MHz
- ⚡ Power over Ethernet: Each SI.GN2.ER(.M)
PoE-capable (802.3af)

GATEWAY NODE – SMART INTEGO

SMART INTEGO WIRELESS NETWORK – HARDWARE

SI GatewayNode 2 for SmartIntego to convert from Ethernet to 868 MHz frequency, including connection capability for an external plug-in power supply (POWER.SUPPLY.2). Transmitting and receiver antenna integrated on router circuit board. Power-over-Ethernet-capable (802.3af)	SI.GN2.ER
GatewayNode 2 for SmartIntego Mercury to convert from Ethernet to 868 MHz frequency, including connection capability for an external plug-in power supply (POWER.SUPPLY.2). Transmitter and receiver antenna integrated on router circuit board. SUPPLIED IN CONJUNCTION WITH MERCURY CONTROLLERS ONLY. Power-over-Ethernet-capable (802.3af)	SI.GN2.ER.M
SmartIntego GatewayNode for extension of range of 868 MHz transmission path; includes connecting terminals for external plug-in power supply	SI.GN.R
SmartIntego GatewayNode to convert from RS485 port to 868 MHz. This must be configured with the SI.GN.CONFIG.UC and the SmartIntego configuration software (SI.SW); includes connecting terminals for external plug-in power supply	SI.GN.CR
Digital Node I/O: Battery operated radio module for analysis of 3 inputs and 1 output (Open Drain). Is integrated into the network via a GatewayNode. Can be used to monitor or control devices.	SI.N.IO
5 m sensor cable to connect to the SI Node IO (SI.N.IO) to detect electronic status changes (e.g. door monitoring)	WN.LN.SENSOR.CABLE

GATEWAY NODE – SMART INTEGO ACCESSORIES

External plug-in power supply 12 VDC / 500 mA / 6 VA for SI.GN2.ER(.M); with 5.5 mm jack plug, connecting cable: about 1.5 m	POWER.SUPPLY.2
External antenna for connecting to SI.GN2.ER(.M), (cable 2.5 m long)	ANTENNA.EXT.868
GatewayNode converter from TCP/IP to RS485 interface for initial configuration of the SI.GN.CR. SI.GN.CONFIG.EC is only required for initial operation and configuration and is not needed for standard operation. All components must be configured with the SmartIntego configuration software (SI.SW).	SI.GN.CONFIG.EC
Tester for analysis of a SimonsVoss SmartIntego radio network at 868 MHz; consists of one base and one mobile station; training required before use.	SI.TESTER.BAMO.EU
Training per hour	DIENST



CONFIGURATION SOFTWARE SMART INTEGO

SOFTWARE SMART INTEGO

The SmartIntego software (SI:SW) is a configuration tool for configuration all necessary settings such as card technology used etc.) for operation of an access control system. Once configuration is complete, SmartIntego makes the necessary network settings (IPsettings, network topology/network addressing) and then the locking devices are programmed for initial operation.

SmartIntego Manager, a component of SI.SW, also has different analysis options within the radio network and for locking devices.

A configuration file from SI.SW is then transferred to the access control system for continued operation.



SUPPORT

SERVICES AND TRAINING

SERVICE PROVISION

On-site project work	PROJECT
Training on-site in building	TRAINING
Services as per service report	DIENST

MOCK-UP

Demo model of digital lock cylinder FD – Wireless Online	SI.MOCKUP.Z4.MI
Demo model of digital lock cylinder CO– WirelessOnline	SI.MOCKUP.Z4.MI.CO
Demo model SmartHandle AX Europrofile – standing– Wireless Online	SI.MOCKUP.SI-S2.A0.WO
Demo model SmartHandle AX Europrofile – standing– Virtual Card Network	SI.MOCKUP.SI-S2. A0.VCN
Demo model SmartHandle AX – Scandinavian Oval without MO – Wireless Online	SI.MOCKUP.SI-S2. E0.WO
Demo model SmartHandle AX – Scandinavian Oval without MO – Virtual Card Network	SI.MOCKUP.SI-S2. E0.VCN
Demo model SmartHandle SnapIn - Wireless Online	SI.MOCKUP.SH.A
Demo model SmartHandle SnapIn DM – WirelessOnline	SI.MOCKUP.SH.A.DM
Robust aluminium case for mock-ups	MK

SIMONS VOSS WORLDWIDE

GERMANY MAIN OFFICE:
SimonsVoss Technologies GmbH
FeringasträÙe 4
85774 Unterföhring

Tel. +49 89 99228-0
info-simonsvoss@allegion.com
www.simons-voss.de

GERMANY
PRODUCTION:
SimonsVoss Technologies GmbH
LindensträÙe 6
06721 Osterfeld
OT Kleinhelmsdorf

BENELUX
SimonsVoss Technologies B.V.
The Base B
Evert van de BeeksträÙt 104
1118 CN Schiphol
Netherlands

Tel. +31 20 6541882
benelux-simonsvoss@allegion.com

FRANCE
SimonsVoss Technologies SAS
Immeuble
« Les Portes de Paris »
1/3, Rue du Rempart
93160 Noisy le Grand

Tel. +33 1 48151480
france-simonsvoss@allegion.com

THE UK
SimonsVoss Technologies Ltd.
1200 Century Way
Thorpe Park, Colton
Leeds LS15 8ZA

Tel. +44 113 2515 036
uk-simonsvoss@allegion.com

ITALY
SimonsVoss Technologies GmbH
Via Torino 2
20123 Milan

Tel. +39 02 72 54 67 63
italy-simonsvoss@allegion.com

Nordic Countries
SimonsVoss Technologies AB
Ostermalmstorg 1
Stockholm 114 42
Sweden

Tel. +46 850 25 66 63

AUSTRIA
SimonsVoss Technologies GmbH
Kärntner Ring 5–7
1010 Vienna

Tel. +43 1 2051160-1146
austria-simonsvoss@allegion.com

MIDDLE EAST
SimonsVoss Technologies
(Middle East) FZE
P.O. Box 184220
Dubai UAE

Tel. +971 4 8815835
uae-simonsvoss@allegion.com

ASIA
SimonsVoss Security Technologies
(Asia) Pte. Ltd.
178 Paya Lebar Road
#04-10 Paya Lebar 178
Singapore 409030
Republic of Singapore

Tel. +65 6227 7318
asia-simonsvoss@allegion.com



This is SimonsVoss

SimonsVoss, the pioneer in remote-controlled, cable-free locking technology provides system solutions with a wide range of products for SOHO, medium and large-sized businesses as well as public institutions. SimonsVoss locking systems combine intelligent functionality, high quality and award-winning design Made in Germany. As an innovative system provider, SimonsVoss focuses on scalable systems, high security, reliable components, powerful software and simple operation. As such, SimonsVoss is regarded as a technology leader in digital locking systems. Our commercial success lies in the courage to innovate, sustainable thinking and action, and heartfelt appreciation of employees and partners.

SimonsVoss is a company in the ALLEGION Group, a globally active network in the security sector. Allegion is represented in around 130 countries worldwide (www.allegion.com).

SimonsVoss Technologies GmbH

Feringastrasse 4

85774 Unterföhring

Germany

Tel. +49 8999 22 80

Fax +49 8999 22 82 22

info-simonsvoss@allegion.com

www.simons-voss.com/en

For general safety and maintenance information, visit www.simons-voss.com/en/security.html

SI.PK.EN Version 2020.02

© Copyright 2020, SimonsVoss Technologies GmbH, Unterföhring, Germany.

All rights are reserved. Text, images and diagrams are protected under copyright law.

The contents of this brochure may not be copied, distributed or modified. You can find authoritative, detailed technical information in the system manual. Subject to technical changes.

SimonsVoss and MobileKey are registered brands belonging SimonsVoss Technologies GmbH.



SimonsVoss
technologies

Made in Germany